

City of Austin Electric Utility



Austin Energy Design Criteria

Effective December 12th, 2023

TABLE OF CONTENTS

1.1.0	INTRODUCTION	3
1.2.0	RELEVANT CITY OF AUSTIN BUSINESS OFFICES.....	4
1.3.0	BASIC REQUIREMENTS OF ELECTRIC DISTRIBUTION SERVICE	6
1.4.0	REQUESTING/OBTAINING ELECTRIC DISTRIBUTION SERVICE	14
1.5.0	TYPES OF PERMANENT ELECTRIC DISTRIBUTION SERVICE	25
1.6.0	STREET LIGHTING.....	69
1.7.0	TEMPORARY DISTRIBUTION POWER.....	72
1.8.0	CUSTOMER ELECTRIC DISTRIBUTION EQUIPMENT REQUIREMENTS.....	75
1.9.0	METERING	82
1.10.0	CLEARANCE AND SAFETY REQUIREMENTS.....	97
1.11.0	DISTRIBUTION NETWORK TRANSFORMER VAULTS	110
1.12.0	DISTRIBUTED GENERATION INTERCONNECTION.....	117
1.13.0	SMALL CELL INTERCONNECTION.....	120
1.14.0	TRANSMISSION AND SUBSTATION REQUIREMENTS.....	121
1.15.0	DISTRICT ENERGY AND COOLING.....	133
1.16.0	APPLICATION REQUIREMENTS FOR AUSTIN ENERGY LAND DEVELOPMENT REVIEW.....	135
1.17.0	GLOSSARY	137
1.18.0	APPENDIX AND EXHIBITS	145

1.1.0 INTRODUCTION

The purpose of this Design Criteria Manual (“Design Criteria” or “Manual”) is to provide criteria, guidelines, definitions, and descriptions approved by the City of Austin (COA) City Council for: 1) the design and installation of the Customer’s electric facilities that will be served by the City of Austin Electric Utility Department doing business as Austin Energy, hereinafter referred to as Austin Energy (or AE), and 2) the safety and reliability requirements that must be adhered to when developing in proximity to existing or planned electric facilities maintained by AE (i.e., Austin Energy’s electric system).

The information contained in this Design Criteria must be used for the design and installation of electrical services in the AE service area. This Design Criteria does not attempt to cover all the situations that might be encountered, required, or requested concerning the construction/installation of an electric service. Specific design requirements and final approval of any installation must be coordinated directly with the appropriate AE business unit which include:

- (A) Distribution Design (AE Design);
- (B) Spots & Conduit;
- (C) Electric Transmission and Substation;
- (D) Pole Attachment Services; and
- (E) AE District Cooling.

Any apparent discrepancy, omission, error, or requirement necessitating further explanation or interpretation in this Design Criteria should be referred to AE Design for final explanation or determination of AE requirements.

The AE Design Criteria is available online at no cost. Go to the website Austinenergy.com, then go to Contractors – Electric Service Design & Planning – “Download a free copy of the Austin Energy Design Criteria Manual (pdf)”.

1.2.0 RELEVANT CITY OF AUSTIN BUSINESS OFFICES

Following is a list of the relevant City of Austin (COA)/Austin Energy business offices including addresses and phone numbers:

AE CALL CENTER	512-494-9400
AE PUBLIC INVOLVEMENT	512-322-6442
AE KEY ACCOUNTS	keyaccounts@austinenergy.com
AE ELECTRIC DISTRIBUTION BUSINESS UNITS:	
ST. ELMO SERVICE CENTER (SOUTH) 4411-B Meinardus Drive	512-505-7500
KRAMER LANE SERVICE CENTER (NORTH) 2526 Kramer Lane, Bldg C	512-505-7000
Distribution Design South: (South of 969/MLK/Windsor Rd.) 4411-B Meinardus Drive - Request for changes to AE infrastructure, power to sites in the South area .	512-505-7682 All requests for changes to AE distribution electrical infrastructure or designs for power to sites will submit to our Design Intake .
Distribution Design North: (North of 969/MLK/Windsor Rd. 2412 Kramer Lane, Bldg C – Request for changes to AE infrastructure, power to sites in the North area .	512-505-7181 (Design Intake)
Distribution Network Design (Downtown Austin) 4411-B Meinardus Drive - Request for changes to AE infrastructure, power to sites in the downtown Network area .	512-505-7682 (Design Intake)
Distribution Standards	AEDistributionStandards@austinenergy.com Requests for distribution equipment purchasing specifications, construction standards, new product reviews, design guides, and other internal common documents are submitted through Distribution Standards Intake .
Development Assistance Center (Permitting & Development Center)	aebspaespa@austinenergy.com
Spot and Conduit (Point of Attachment) North & South	aeelectricspots@austinenergy.com
All Streetlights (North & South)	Call 311
Work Management North, Civil Inspections North – Schedules installation of AE infrastructure, civil inspections, for the North area.	kramerwm@austinenergy.com
Work Management South, Civil Inspections South – Schedules installation of AE infrastructure, civil inspections, for the South area.	stelmowm@austinenergy.com
Civil Inspection , North & South Major Ductbanks, downtown Network civil Inspections	512-505-7008

<p>AE Distribution Metering Operations – Metering equipment - Metering equipment information and general metering questions for large residential and large commercial</p> <p>AE Distribution Metering Dispatch Scheduling CT Inspections, 2500 Montopolis Drive</p> <p>Advanced Metering Systems & Engineering – Modular metering, solar variances, metering specifications, and general advanced metering questions. 2500 Montopolis Drive</p> <p>AE Service Dispatch (North & South)</p> <p>Controlled Service Outages (Disconnect/Reconnect)</p> <p>AE Solar Inspections</p>	<p>aedistributionmetering@austinenergy.com</p> <p>aedmodispatch@austinenergy.com</p> <p>AEAdvancedMeteringEngineering@austinenergy.com</p> <p>StElmoDistribution@austinenergy.com</p> <p>aecorequest@austinenergy.com</p> <p>solarinspections@austinenergy.com</p>
<p>Electric Transmission and Substation 2526 Kramer Lane, Bldg C</p>	<p>512-322-6442</p>
<p>Pole Attachment Services Infrastructure Agreements, Applications, and Construction Program Manager</p>	<p>512-322-6160</p> <p>512-322-6396</p>
<p>District Cooling (On-Site Energy Resources) Email: OSERSubmittals@austinenergy.com</p>	<p>Downtown: 512-914-3997 Domain: 512-987-4421 Mueller: 512-658-7395</p>
<p>COA Development Services Department 6310 Wilhelmina Delco Dr (Permitting & Development Center)</p> <p>Austin 311</p> <p>Building Inspection Division (Electrical Inspection) – Schedule electrical inspection.</p> <p>Austin Build + Connect - Obtain permits, pay for permits, and schedule inspections online.</p>	<p>Call 311 / DSDHelp@austintexas.gov 512-974-2000, if outside the City limits</p> <p>512-974-2000</p> <p>512-974-9405</p> <p>https://abc.austintexas.gov/web/permit</p>
<p>One Call – Call before you dig! City of Austin – 911 Addressing To create a 911 address</p>	<p>Call 811 addressing@austintexas.gov</p>

1.3.0 BASIC REQUIREMENTS OF ELECTRIC DISTRIBUTION SERVICE

Section 1.3.0 discusses the general characteristics and conditions and the basic requirements that apply to all the types of electric service that AE provides from the AE distribution system. (See 1.17.0 Glossary)

1.3.1 AE Electric Distribution Service Voltages and Maximum Demand Ampacities

- A. **Underground/Vault Network Service Voltages and Maximum Demand Ampacities for Residential and Commercial Only in Network Area.** Electric service is normally available in the AE Network Area (see map in Section 1.11.5) as shown in Table 1.5.1.2. (See Section 1.3.2.)
- B. **Commercial Electric Service Voltages and Maximum Demand Ampacities.** Commercial electric service is normally available in non-residential AE service areas (excluding network) as shown in Table 1.5.2.2. (See Section 1.3.2.)
- C. **Residential Electric Service Voltage and Maximum Demand Ampacity.** Electric residential service is normally available in the AE service area (excluding network) as shown in Table 1.5.3.2. (See Section 1.3.2.)

1.3.2 Availability of AE Facilities

Not all service voltages, service styles, or demand ampacities are available at all locations. The characteristics of electric service (voltage, number of phases, capacity, and so forth) that are available and can be supplied at a given location are the sole determination and judgment of AE Design. (Contact AE Design for additional information.)

1.3.3 One Point of Service and One Service Voltage

As a standard service, AE supplies one point of service, at one service voltage, to a single building or point of service, located on a single lot or tract of land. The electric service must be of sufficient ampacity and capacity to provide power to all buildings or structures located on the same single tract of land. An additional service drop for either temporary or permanent services may be approved by AE Spots and Conduit and/or AE Design, respectively. Some other exceptions allowing multiple points of service are noted in this Design Criteria based upon load size, building size, and building occupancy. Additional exceptions may be allowed under the requirements for Excess Facilities/Excess Cost Policy (See Section 1.3.13). Exceptions that are not expressly allowed under this Design Criteria Manual must be reviewed and approved by the AE Design or Spot/Conduit department.

Note: For Network Area Vault(s), on a single lot or tract of land, Network Design will allow each building located on the same single lot or tract of land to house its own network vault(s). This exemption does not apply to services that are 800 Amps or less of 120/208V that are located within the Network Area.

1.3.4 Point of Service (POS)

Unless otherwise specified by AE Design or specified in the Agreement for Electric Service (Letter of Agreement), the point of service is the point (meter socket, pedestal, service distribution enclosure, pull-box, or other AE-approved enclosure) at which AE's and Customer's conductors are connected or terminated. (AE will make these connections/terminations.)

1.3.5 Electrical Facility Ownership

Unless otherwise agreed to in writing, Austin Energy owns all electric facilities in the public right of way and the Customer and AE owns all electric facilities on their respective sides of the point of service with the exception of the meter, which in all cases AE will own. AE and the Customer shall generally assume all maintenance and operation responsibilities of the facilities on their respective sides of the point of service.

AE takes ownership and has full exclusive rights to use all civil work that is installed by the customer and AE for the purpose of installing AE infrastructure. For customer-installed civil work, AE takes ownership at the passing of AE inspection.

1.3.6 AE is not required to perform maintenance on the Customer’s electrical facilities beyond the point of service or easements.

The Customer must grant AE an electrical easement, using standard City forms and signed by the property owner, which allows AE access for installation and maintenance of AE-installed and owned electrical facilities starting at the property line as determined by AE Design.

All easement documents must be prepared by the AE Public Involvement business unit and mailed to the owner(s) for a signature. The completed documents must be returned to AE before AE begins installation of electrical facilities on the Customer’s property.

NOTE: All pad-mounted and vault equipment (transformers, switchgear, and such) must be installed on the Customer’s property.

Based on City Code Section 15-9-37. By accepting electric service from AE, the Customer accepts and grants to AE the construction, placement, and maintenance access rights for these facilities (see also Section 10 – *Clearance and Safety Requirements* and specifically Section 1.10.10 *Customer Activities in Utility Easements*.)

1.3.7 Color Coding of Customer’s Service Conductors

Color coding of Customer’s service conductors must be as follows in Table 1.3.7. [Phase arrangement shall be (A), (B), (C), front to back, top to bottom, or left to right, as viewed from the front of the service equipment and metering equipment. (N) shall be neutral.]:

TABLE 1.3.7 COLOR CODING OF CUSTOMER’S SERVICE CONDUCTORS				
Service Type	Phase			
	A	B	C	N
120/240V, Single-Phase, 3-Wire	RED	BLACK		WHITE
120/240V, 3-Phase, 4-Wire, DELTA				
Through Metering Equipment (see Note 2 and Note 3)	RED	BLACK	ORANGE (High-Leg)	WHITE
In Service Equipment	RED	ORANGE (High-Leg)	BLACK	WHITE
120/208V, Single-Phase, 3-Wire	(Note 1)	(Note 1)	(Note 1)	WHITE

120/208V, 3-Phase, 4-Wire, Wye	RED	BLACK	BLUE	WHITE
277/480V, 3-Phase, 4-Wire, Wye	BROWN	YELLOW	PURPLE	NATURAL GRAY

Green must be used for the *grounding conductor* only.

Marking of conductors at all termination points will be approved for sizes #6 AWG and larger.

NOTE 1: Per City Code, Section 25-12-114, 310.110(C)(1)-Conductor Identification– ALL COLORS MUST BE CONSISTENT THROUGHOUT EACH SYSTEM. (Four-wire wye secondary services from AE to multiple occupancy buildings require that the Customer install wiring to each occupant that satisfies the color consistency requirement of this section. (Contact COA Development Services Building Inspections division.) Where three-phase service is used to provide single-phase service to individual occupants, the load must be balanced between the phases as required by the latest edition of the NEC.

Note 2: Where an Austin Energy transformer serves multiple meter banks, Austin Energy shall label (tag kit) all secondary service conductors as the meter bank that it serves. Customer shall label secondary service conductors at the meter bank as the transformer that serves it. (Austin Energy will provide this inspection).

NOTE 3: On 120/240 volt, three-phase, 4-Wire, Delta connected CT services, the high leg must be pulled through the CT in the C phase position. If the high leg is pulled in the center CT, AE will not accept the installation. (See Section 1.5.2.4.B.10.)

NOTE 4: High-leg Phase Conductors. Particular attention must be given to marking high-leg phase conductors feeding from a 3-phase, 4-wire, 120/240V delta secondary source. The high-leg shall be effectively identified in accordance with NEC 230-56 (marked by orange tape).

The high-leg shall always be connected as follows:

In meter sockets, including pre-wired transockets	To the right-hand terminals
In CT enclosures	To either the right hand CT (left to right) or the bottom CT (top to bottom)
In service equipment	To the center bus

1.3.8 Customer Electrical Facilities that Cross Property Lines

A Customer may not extend or connect any electrical facilities served from AE electric energy sources across property lines to a Customer's installation on another property or across, under, or through a public street, alley, right of way, public space or other private space in order to provide electric service for this adjacent property. However, a Customer who owns physically adjacent properties that are developed and operated as a unified development may extend or connect the installation to lines across or under the property lines of said adjacent properties as interpreted by AE in order to serve said properties through one point of service.

Such a single point of service shall be maintained only as long as the physically adjacent tracts remain operated as a unified development. Pursuant to City Code, Section 15-9-123, AE may discontinue service to a Customer in violation of these provisions until AE determines that any unauthorized connections have been removed. In addition, AE may require that the initial installation allow for and that the Customer maintains provisions for providing electric service to the separate properties (with easements and such as determined by AE) in the event of a future cessation of operation as a unified development.

1.3.9 Single-Phase/Three-Phase Service

Single-phase 120/240V service is the basic standard electric service provided throughout the AE service area (except network). *Three-phase service* is furnished only where the Customer's load and equipment warrants a three-phase service and where AE has the necessary facilities installed and available.

NOTE: The Customer is responsible for installing devices to protect the Customer's three-phase equipment from 'single-phasing', which is the loss of one phase.

See also Section 1.5.2.4.B.11 and 12.

Note: For disconnect and meter room requirements, refer to Section 1.8.0 & 1.9.0. Any deviation requires advanced written approval from Distribution Metering Operations prior to construction.

EXCEPTION: For 277/480V three-phase self-contained meter sockets and for 480V three-phase, or any low voltage secondary voltage service above 300V up to 600V phase to phase or leg to leg, *a service load break disconnect switch shall be installed in close proximity to and on the line side (ahead) of the metering equipment.* [Line-Disconnect-Meter-Load]

NOTE: Customer changes/upgrades to existing service entrance facilities on the Customer's side of the point of service (such as replacing the main disconnect switch) may require that the entire service entrance is brought up to current code requirements. Check with the COA Development Services Department Building Inspections division.

1.3.10 Voltage Stability and Continuity

AE does not supply the special or conditioned power requirements required by some Customer loads such as computers and specialized electronic equipment. The Customer shall provide and maintain equipment, on the load side (after) of the metering equipment, which ensures the additional voltage stability and continuity necessary for the Customer's equipment [such as UPS Systems (Uninterruptible Power Supplies)].

1.3.11 Electric Service Reliability

AE will use reasonable diligence to supply steady and continuous service consistent with good management and construction practices, but does not guarantee the service against irregularities, interruptions, or variations. While most equipment and devices are designed and built to operate on a wide band of supply voltage, AE will endeavor to maintain the voltage level within industry-accepted standards, $\pm 5\%$ at the point of service. However, AE will incur no liability to the Customer for failure to comply with this service standard.

1.3.12 AE Line Extension Policy

In accordance with Austin City Council Resolution No. 20140612-057, Austin Energy collects 100% of the costs for line extensions and new infrastructure associated with requests for new electric service, with an exemption for certain affordable housing. A Customer applying for new service will be charged all estimated costs for labor and material required to modify existing infrastructure and to extend service from Austin Energy's existing infrastructure to the Customer's point of service to serve the requested load, sometimes referred to as "Contributions in Aid of Construction", or "CIAC". This includes the service drop and meter.

Customers seeking an affordable housing exemption for all or a portion of these costs must provide Austin Energy with documentation from the Housing and Planning Department demonstrating that the Customer's premises meet City standards for affordable housing under the S.M.A.R.T. Housing Program as described in the City of Austin Land Development Code. If the affordable housing standard is met, *a waiver shall be applied to the portion of the line extension fees attributed to serving the affordable housing portion of the development according to the following calculation formula:*

*Line Extension Fees * % of Development that is Residential Affordable Housing Based on Housing Units.*

Projects containing at least 75% of the overall residential portion as affordable shall receive 100% fee waiver for the residential portion of the project. For these projects, residential amenities, service and common areas, and accessory spaces are considered part of the residential portion of the development.

For mixed use development, the % of Development that is Residential Affordable Housing should be based on the combined residential and commercial square footage (i.e., the entire building area) so that the fee waiver only applies to the residential portion of the development. Affordable live/work units will be considered 100% residential for this calculation.

Waivers for affordable housing in PUDs are only applicable when new affordable housing units are built.

The line extension fees that are subject to the waiver is limited to costs associated with standard electric service. Any excess costs and/or excess facilities that exceed what Austin Energy would provide as adequate and reliable standard electric service to serve the Customer's electrical demand and energy needs must be paid by the Customer in full as outlined in the current Council Approved Fee Schedule and Austin Energy's Excess Cost Policy. If a Customer that receives a waiver under the affordable housing exemption fails to meet their affordable housing obligations, the previously waived fees must be returned to Austin Energy in full.

1.3.13 AE Excess Facilities/Excess Cost Policy

The quantity and size of AE electric distribution infrastructure on the AE side of the point of service is at AE's discretion. Regarding equipment and material sizing, Austin Energy is bound to the National Electric Safety Code but not to the National Electric Code for facilities on the utility side of the point of service. Excess cost applies to anything requested by the Customer that exceeds what AE would provide as adequate and reliable standard electric service to serve the Customer's electrical demand and energy needs. This cost applies but is not limited to Customer requests for conversion of overhead to underground service, excess transformer capacity, equipment / work to increase reliability, specific placement or routing of AE facilities, relocations/removals of AE facilities, additional points of service, and other similar services. The Customer will be required to pay the full amount of any excess facilities and/or excess costs including any applicable fees as outlined in the current Council Approved Fee Schedule, Customer-requested and necessitated overtime, and any anticipated future operating costs.

For underground service, AE requires that the Customer install all civil work for the AE facilities.

Any specialized service agreement, such as dedicated feeds and dual feed services, is between Austin Energy and the customer who is a party to the agreement. This type of agreement is not transferrable and is not assigned to a new customer. Once an electric account is closed or transferred to a new owner, the specialized service agreement is terminated, and the service is converted to a standard service that is sufficient to serve the new customer. If the new customer would like the specialized service, they must ensure that they have the necessary skills and resources to maintain the specialized service in order to prevent adverse effects on the electric grid and must enter into a new agreement with Austin Energy for that service.

1.3.14 Taxes

The comptroller has termed the amount charged by utilities as reimbursement for the infrastructure necessary to deliver utilities to customers as "Contributions in Aid of Construction (CIAC)." If the person paying the CIAC also purchases utility service delivered by the infrastructure, the CIAC is considered part of the cost of providing utility service and is taxable to the extent that the utility service is taxable. This is dependent upon on how the account is set up as commercial accounts are taxable but residential accounts are not. If the person making the CIAC reimbursement will not purchase electricity or does not know if such a person will purchase electricity, then the CIAC is not taxable. To be free of tax liability, the developer must provide an exemption certificate specifically claiming the CIAC is for development purposes and is not related to the purchase of electricity. This certificate clears the utility of responsibility for collecting the sales tax if deemed the CIAC is taxable at a later date.

1.3.15 Front Lot Line Construction Requirement

AE requires that all new construction of AE primary voltage overhead and underground facilities be installed such that they are "truck-accessible" both for construction and for any future maintenance or modification. This normally necessitates that these AE facilities be installed at the front of the Customer's property or adjacent to a street, road, or other paved surface. Rear lot line construction for new areas will only be permitted where there are paved alleys or other permanent roadways that are AE truck accessible. (See Section 1.3.16).

1.3.16 Access to AE Facilities

Truck access to the site where AE equipment will be installed, as required by the specific project, shall be provided by the customer with a minimum horizontal width of 12 feet and a minimum vertical clearance of 16 feet. Where access is by a paved road or another all-weather prepared surface, the surface shall be

capable of supporting, without damage to the road or surface, a total vehicle weight of 72,180 pounds with a maximum rear axle weight of 32,530 pounds. Set-up area in front of equipment shall be a minimum space of 20 feet x 35 feet and a minimum vertical clearance of 35 feet. For all vehicle types that AE may potentially use to maintain and install AE infrastructure, AE vehicles must have the ability to turn around or exit the property. See Section 1.10.0 for clearance requirements above and around equipment. All AE equipment shall be located a minimum of 2 feet above the 100-year floodplain as defined in the latest COA Land Development Code (LDC).

1.3.17 Non-conforming Conditions

Austin Energy requires that customers adhere to the provisions of the applicable NEC, NESC, City of Austin Code and Austin Energy Design Criteria Manual at the time of installation. To the extent that the requirements of the Austin Energy Design Criteria Manual exceed the requirements of the NEC, NESC and City of Austin Code, Austin Energy has discretion to allow existing site conditions that do not conform to the full requirements of the Design Criteria Manual (Non-conforming Conditions) to continue if such Non-conforming Conditions do not violate the provisions of the currently applicable NEC, NESC and City Code, and if it can be determined that such conditions do not create an unsafe situation, do not negatively impact Austin Energy's ability to safely and efficiently operate and maintain its electric infrastructure, and do not disrupt or negatively impact Austin Energy processes. Customer must receive written approval from Austin Energy for such waivers.

1.3.18 Austin Energy Construction Standards

All installations on the utility side of the point of service must be installed according to the Austin Energy construction standards, which contain the applicable construction standard for each installation as determined by Austin Energy. Any variance from the construction standard must be approved by Austin Energy in writing. To request information on the construction standards, contact the Austin Energy Distribution Standards business unit.

1.3.19 Relocation of AE Facilities

Where feasible, AE will temporarily (or permanently) relocate AE facilities at the Customer's expense. Such relocations often require considerable planning and effort. The Customer should consult with AE Design at the beginning of the project for both construction power and permanent service.

Relocation of distribution lines and associated equipment is performed pursuant to utility needs and operations, not at the request of a property owner/customer/developer, such as for the purpose of space or convenience. Austin Energy will not, at a property owner's request, temporarily or permanently relocate distribution lines from being on or adjacent to one property to being on or adjacent to another property without written consent of the property owner to which the distribution lines would be relocated adjacent to. Obtaining this written consent and easement is the responsibility of the property owner making the request.

1.3.20 Customer Switchover Policy

In a dually certified service area, a Customer is required to pay all current balances before being disconnected from the AE system. The Customer will also be required to pay, in advance, for any costs associated with the disconnection of service. There will not be a disconnect fee in addition to the above costs. A Customer switching to the AE system from another system will be required to present a receipt or other evidence from the disconnecting utility that all current charges for electric service and for the service disconnection have been paid.

1.3.21 Three Mega-Watt Demand and Larger Customer Requirements

The requirements for Customers requesting service for three (3) mega-watts or more of maximum demand load (as requested by the Customer or estimated by AE Design) may require additional infrastructure to support the load requirements.

1.3.22 Underground Only Service Areas (Non-Network Areas)

Some areas or developments may have developer commitments to underground (where only underground is available) or community/city-imposed restrictions that obligate the Customer to request underground service from AE. The Customer must still meet the conditions and pay any additional costs required by AE in Sections 1.3.12 and 1.3.13 and this Design Criteria for underground service. Contact AE Design.

1.3.23 Americans with Disabilities Act (ADA)

Austin Energy complies with the ADA regarding the installation of all new Austin Energy facilities.

1.3.24 Easements for Electric Distribution Facilities

Austin Energy obtains easements to ensure that it has the property rights necessary for the safe construction, operation, maintenance, and access to its electric distribution facilities and to ensure that necessary required clearances are maintained. These easements cover the physical location of the distribution facilities, the area needed to access its facilities, areas needed for construction, operation and maintenance of AE's facilities, and areas that, if developed, would violate required electrical clearances, or interfere with access to AE facilities. If electric distribution easements that were obtained in the past are not adequate to provide these protections, then AE works to expand existing easements or obtain additional easements.

1.4.0 REQUESTING/OBTAINING ELECTRIC DISTRIBUTION SERVICE

Section 1.4.0 provides the general process and customer requirements for obtaining electric service from Austin Energy.

1.4.1 AE Service Area Questions

The AE Call Center (512-494-9400) is the first place to call when applying for service in order to establish billing information concerning a new service request (or to request electric service reconnects and disconnects).

For locations outside of the City of Austin and for any location where there is a question as to which electric utility will be the service provider, the Customer should contact the AE Public Involvement business unit or Development Assistance Center. AE Public Involvement will determine if the service location is within the Austin Energy service area and provide an Electric Service Availability Letter (if requested) confirming that the point of service location is in the Austin Energy service area.

1.4.2 Electric Distribution Service Requests

The necessary steps to obtain a new electrical service or for modifications to existing electrical infrastructure is described in the following sections. All infrastructure shall be built according to the applicable Austin Energy Distribution and Network Construction Standards and meet all requirements specified in this Criteria Manual. Network service is only available in the designated downtown Network Area. See the AE Network Area Map for areas served by AE network facilities.

Customers may submit requests online on the Austin Energy Design Intake Form. This form can be located on the Austin Energy website.

1.4.2.1 Electric Service Planning Application (ESPA) and Building Service Planning Application (BSPA) and Distributed Generation Planning Application (DGPA)

An ESPA (Electric Service Planning Application) must be submitted to the appropriate Austin Energy Design business unit, along with all required documents, to obtain a design for electric power to new developments and for changes to existing electric services. The ESPA is also required by the City of Austin Development Services Department to obtain an Electric Permit. The ESPA can be obtained online at www.austinenergy.com, from the Development Assistance Center, or from the AE Design Department.

A BSPA (Building Service Planning Application) is required by Austin Energy and is collected by the City of Austin Development Services Department to obtain a building Permit. The BSPA is available online at the City of Austin Development Services Department website under the Residential Building Review section or at the Development Assistance Center (DAC) kiosk.

When installing a distributed generation (DG) system that will interconnect ahead of the AE meter, submit an approved Distributed Generation Planning Application (DGPA) with the ESPA. If the DG system subsequently changes, a new DGPA and new a ESPA must be submitted. (See Distributed Generation Interconnection section.)

1.4.2.2 New Customer Demand Load Determination

On the ESPA submitted by the customer to Austin Energy, the Customer must specify the total undiversified connected demand load for each equipment item or load category so that AE can

appropriately size the AE electrical service facilities.

In the Network Area, the sum of the total maximum nameplate rating of service disconnects or circuit breaker must be used for Customer load determination. Rating of the disconnected equipment must be determined from the nameplate maximum ampacity rating, not the fuse/circuit breaker or relay setting. The maximum number of disconnects must be in accordance with the currently-effective NEC.

1.4.2.3 Service-Only for Services Equal to or Under 350 Amps Single-Phase or 225 Amps Three-Phase in the Non-Network Area.

Section 1.4.2.3 provides the general process and customer requirements for obtaining electric service from Austin Energy for services sized equal to or under 350 amp single-phase or 225 amp three-phase in the non-network area where service size is per the total number of disconnects or maximum rating of the manufacturer's nameplate, not the fuse/circuit breaker or relay setting,

- A. Submit a completed ESPA to the Development Assistance Center along with a plot plan. Include a scaled elevation drawing for any structures that exceed a single story. One Stop will evaluate the customer's electrical needs and the service already available at the site to determine if the service can be provided as a "Service-Only". If One Stop determines that the project requires more electrical infrastructure than is described as "service-only", the project will be forwarded to the appropriate Austin Energy Design business units.
- B. "Service Only" to Residence or Commercial Customers applies to non-network areas where adequate AE facilities are available at the location where the electric service drop or service lateral requirements are needed as determined by the combined main disconnect capacity using the manufacture's ratings. (Note: If the load is more than 320 amps continuous, then the service must be upgraded to instrument-rated CT service and go through the Design Intake/Submittal process). The Customer should contact the AE Development Assistance Support for ESPA approval and to determine service availability and service requirements.
 - a. For requests for new "Service Only" electric service connections in the City of Austin planning jurisdiction, the customer must submit a completed ESPA to the City Development Assistance Center and receive written approval in order to obtain an electrical permit to commence work on any electrical equipment. Once the installed electrical equipment passes electrical inspection and all permits are closed out, the customer may apply for temporary or permanent electric service through Austin Energy's Call Center.
 - b. If the spot cannot be completed due to the new construction or new addition framing, the customer must contact the AE Spot & Conduit Section (via email aeelectricspots@austinenergy.com) before starting any electrical installation to request spotting of the point-of-attachment for overhead services or point of service location for underground service laterals once framing is complete. An AE Field Ops Consult Fee will be assessed if any work begins prior to an approved spot location.
- C. For requests for new electric service connections in which the customer is remodeling, constructing, or modifying a structure, the customer is required to submit a completed BSPA and required plot plan, elevation drawings, and survey identifying all existing

electric facilities and gas meter to residential plan review for building construction (Residential Intake submittal can be found by using the [Residential Building Permit Web Form](#)). The BSPA is only needed when the exterior of a structure is being modified or a new structure is being added to the residential site.

- D. For electric service requests made through the expedited City of Austin process, the customer must submit a completed ESPA to the Development Assistance Center. Upon approval of the ESPA, the customer is eligible to receive electric service from Austin Energy once all permits are issued and inspections are closed out.
- E. The customer must submit a completed ESPA to the Development Assistance Center and receive written approval in order to obtain an electrical permit to commence work on any electrical equipment. Once the installed electrical equipment passes electrical inspection and all permits are closed out, the customer may apply for temporary or permanent electric service through Austin Energy's Call Center.
- F. Determining Meter Location and Point of Service for "Service Only" to Single Unit Residential and Small Commercial. (Single-phase 120/240V electric service of 350 amps or less or three-phase electric service of 225 amps or less of combined main disconnect capacity as determined by the manufacturer's equipment rating.)
 - a. The Customer must contact the AE Spot & Conduit business unit to identify the point of service location prior to beginning electrical work. Spot & Conduit will provide the attachment height information and the point of service location for underground service laterals. The Customer must obtain this information before starting any electrical installation.
 - b. The AE Spot & Conduit business unit designates the point of attachment (not the meter location) for residential services up to 3 meters and approves the ESPA form for new single unit residences and for small commercial. Please email aeelectricspots@austinenergy.com (The Spot & Conduit business unit will refer the service request to AE Design for large services, for all services to five meters or more, or if any construction other than installing a service drop or a service lateral is required.)
 - c. The point of attachment (the point where the AE service contacts the Customer's structure or building) shall be located on a permanent building or structure at a point nearest AE's closest suitable voltage source (such as a pole, service box, pull-box, or transformer). Multiple meters shall be grouped at one location.
 - d. The Spot & Conduit business unit will leave a suitable marker (such as spot card or stake) to identify the location of the point of service. The marker shall remain on site adjacent to the point or service location until after the final COA electrical inspection has been completed.
- G. The Spot & Conduit business unit will also inspect the residential or commercial underground service conduit installed by the Customer (if any) ahead of the AE meter. Customers are prohibited from backfilling a trench or encasing 90-degree bend(s) or conduit until the inspection has been completed and approved. The service will not be installed and energized until the conduit is covered and the trench backfilled. For all underground services fed out of an underground pull box, the pull box that feeds the service must be located and exposed.

NOTE: Commercial customers must install, own, and maintain their underground service lateral (see 1.5.2.2).

- H. Meter Equipment Installations. Prior to purchasing and installing any equipment, the Customer must contact the AE Distribution Metering Operation business unit for approval of the service equipment. See 1.9.0 – Metering section for requirements.
- I. Connection of Service - AE will schedule the new service for installation after the Customer has completed the following:
 - 1. Applied for electric service with AE.
 - 2. Obtained approval of ESPA and/or BSPA from Development Assistance Center, AE Spots and Conduit, or AE Design
 - 3. Obtained a COA electric permit and all required permits.
 - 4. Completed all work per the requirements of the AE Spots & Conduit business unit and the AE Metering business unit.
 - 5. Passed all the required inspections.
 - 6. Applied for Service and set up an account with Austin Energy.
- J. AE should receive notification of a passed electrical inspection from the COA (and all other governing entities) three regular working days before the service can be energized. (Call COA Permit and License Center or the AE St. Elmo Dispatch Office for information concerning the status of the required permits and inspections.)
- K. WorkFlow Process for “Service Only” Services and Services Equal to or Under 350 Amps Single-Phase or 225 Amps Three-Phase.

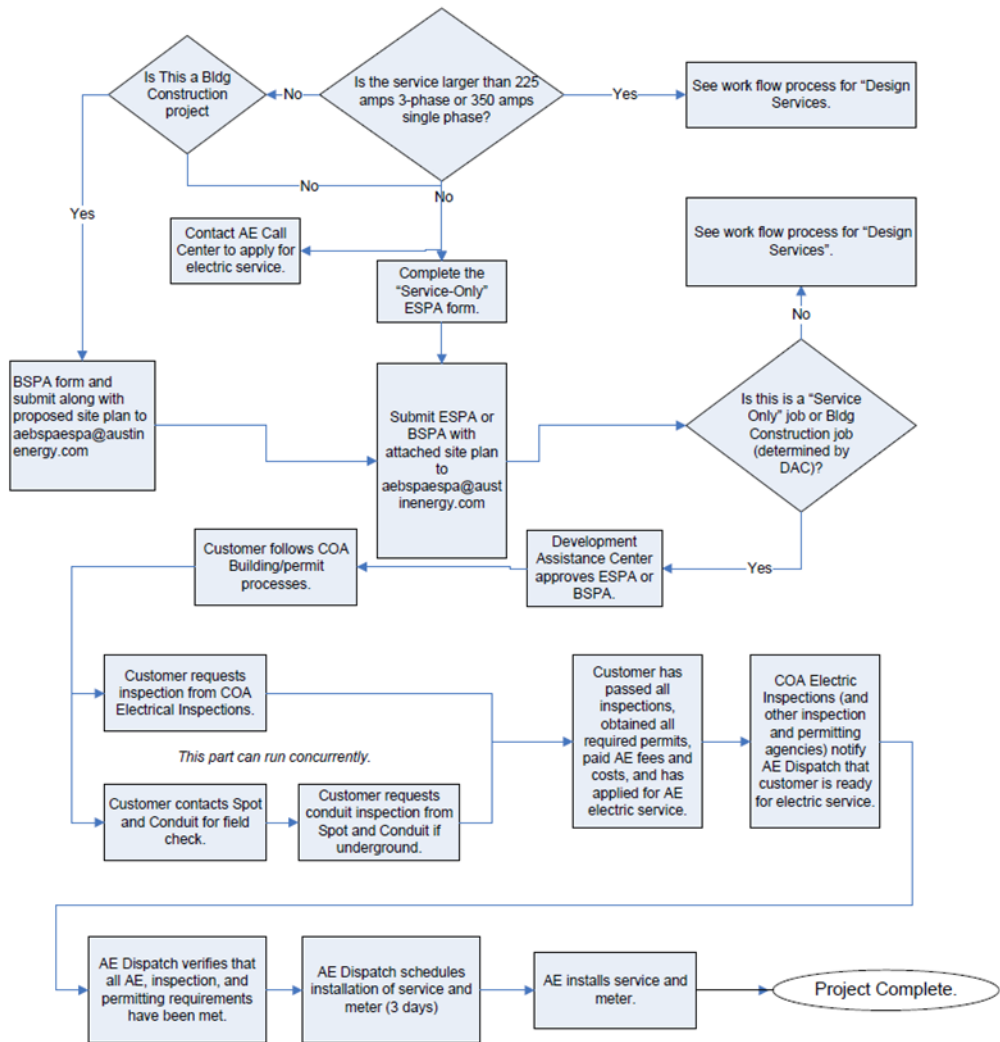

1.4.2.4 Design for Services Over 350 Amp Single-Phase or 225 Amp Three-Phase, All Projects in the Network Area, and All Service Requiring an Austin Energy Design,

Section 1.4.2.4 provides the general process and customer requirements for obtaining electric service from Austin Energy for services sized over 350 amp single-phase or 225 amp three-phase in the non-network area. (Instructions for submitting requests for these services or designs for changes to Austin Energy infrastructure can be found on the [Austin Energy website](#).)

- A. Submit a completed ESPA to the appropriate Austin Energy [Design Intake](#) business unit with supporting documents according to the following project types. Additional drawings and information may be requested depending on the nature of the request. Project drawings submitted by customers must be according to the section titled "Customer Drawings Specifications". The processes described below is separate from the Land Development application process and may result in modifications to an approved site development application to meet the electric design, safety, and reliability requirements found in this manual.

- i. Apartments, Commercial, Multifamily, Mixed Use, and Subdivisions – Submit AutoCAD project drawing of the approved site plan, a riser diagram, and 911 address verification form. For multi-storied infrastructures elevation plans may be requested.
 - ii. Relocation/Removal/Maintenance of Existing Infrastructure – Submit a brief description of the project needs, the addresses affected, and AE pole/equipment number(s). Relocations/Removal due to site projects require an AutoCAD drawing of the approved site plan. For multi-storied infrastructures elevation plans may be requested.
 - iii. Streetlights – Submit a brief description of the lighting needs and the addresses affected. (See section 1.6.0 titled "Street Lighting")
- B. Determining Meter Location and Point of Service. AE Design will determine the meter location(s) and point(s) of service.
- a. Prior to purchasing and installing any equipment, the Customer shall contact the AE Distribution Metering Operation business unit for approval of the service equipment. See 1.9.0 – Metering section for requirements.
- C. Inspection of Any Required Customer-Installed Civil Work. AE Work Management inspects all non-Network underground installations for developments that exceeds the 'service only' requirements where AE installs conductors in customer-installed facilities, including, but not limited to the following:
- 1. Primary cable, secondary cable, and service lateral conduit and all service boxes and pull-boxes.
 - 2. Padmount transformer/equipment concrete pads (including 2-foot secondary conduit stub-outs)
 - 3. Secondary/primary risers including the pull-box, conduit to pole, and 10-foot riser conduit up the pole.
- D. Connection of Service - AE will schedule the new service connection after the customer has completed the following:
- 1. Obtained approval of ESPA from AE Design.
 - 2. Obtained a COA electric permit and all required permits.
 - 3. Completed all work per the requirements of the AE Design and AE Distribution Metering.
 - 4. Passed all the required inspections.
 - 5. Applied for Service and set up an account with Austin Energy.
- E. AE should receive notification of a passed electrical inspection from COA (and all other governing entities) three regular working days before the service can be energized. (Call COA Permit and License Center or the AE St. Elmo Dispatch Office for information concerning the status of the required permits and inspections.)
- F. Work Flow Process for Services Over 350 Amp Single-Phase or 225 Amp Three-Phase, All Service Requiring an Austin Energy Design, and All Projects in the Network Area:

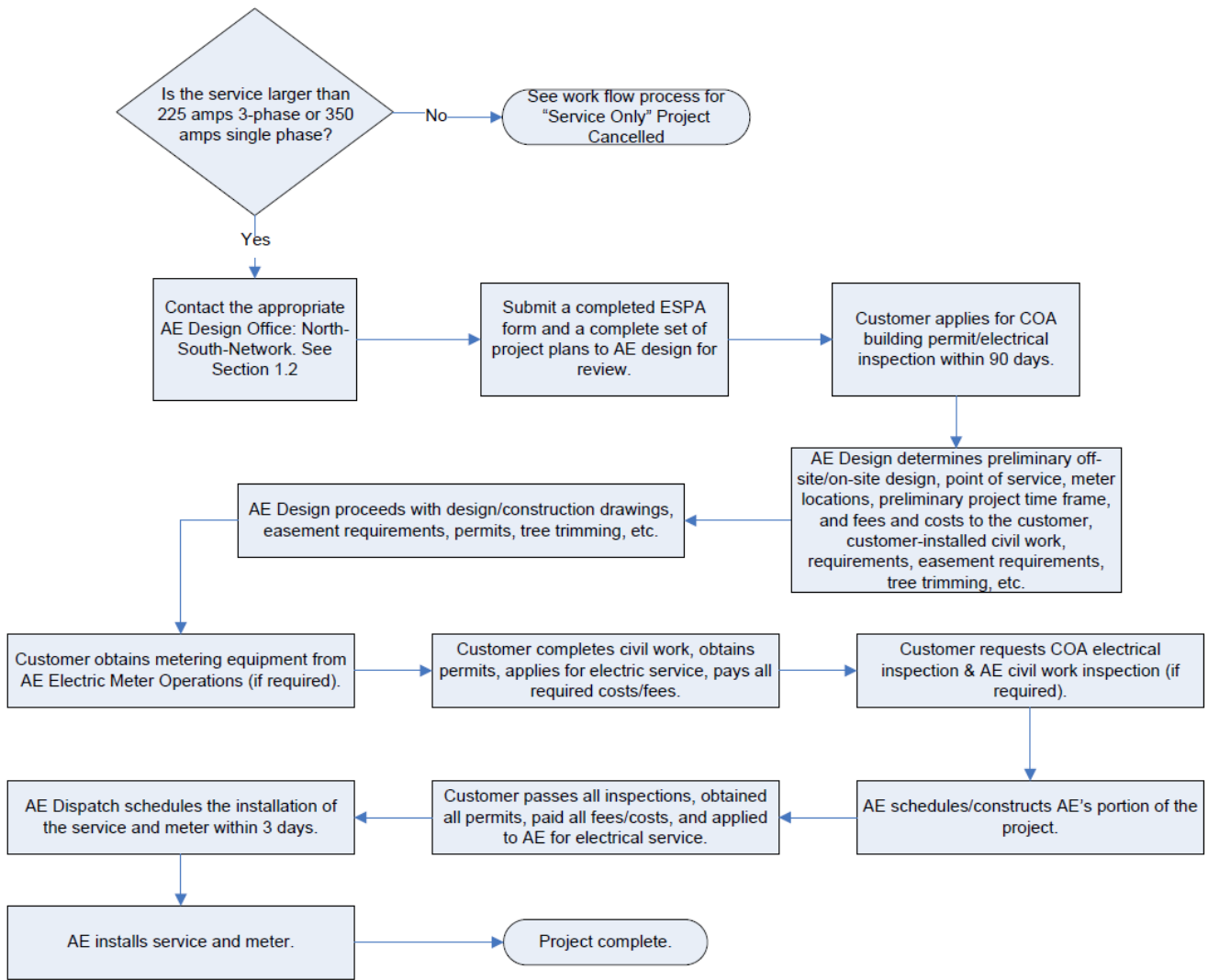

1.4.2.5 Service Requests for Mobile Food Vending

- A. Each Customer at a Multiple Mobile Food Vendor Location must provide Austin Energy a completed ESPA and a current copy of their Mobile Food Vendor's food permit issued by the Austin Public Health. Each Mobile Food Vendor unit must have a separate address created through [Address Management Services](#).
- B. Austin Energy will provide one point of service to each location with multiple Mobile Food Vendors, and individual meters can be established by each Customer at this location. One service can supply all vendors on that site, allowing sub-metering on the load side of the meter. See 1.9.0 for grouping of meters.
- C. For Mobile Food Vendor Locations with multiple Customer facilities, such as, but not limited to, mobile Food vendor food courts, music venues, restrooms facilities, pavilion areas, and site lighting, the ESPA submitted by the Customer must include the total aggregated connected electric load requested.
- D. For Mobile Food Vendor Locations in which more than two electric services are requested, the electrical services must be designed in accordance with NEC requirements for a Recreational Vehicle site. In the ESPA, Customer shall include a scaled drawing for the location to be served.
- E. All mobile food vending must have a power supply from a permanent meter loop pole or from a separately metered service if associated with a brick-and-mortar structure on the site.
- F. All Customer electrical wiring at the Mobile Food Vendor Location must be in accordance with City of Austin Electrical Code requirements.
- G. AE Design Criteria Sections 1.3.3, 1. 3. 8 and 1.3.13 apply to the new electric services that are requested.

1.4.2.6 Customer Drawings Specifications

The Customer is responsible for assuring that the project data supplied to AE is current throughout all of the project design phases. If the Customer has not provided the most up to date version of project data to AE, the project construction schedule could be negatively impacted. AE acknowledges that the Customer has no responsibility for the accuracy or completeness of the data in the "as-built" stage of the electrical design.

All drawings submitted by the Customer to Austin Energy must be according to the following specifications:

Customer CAD File Requirements:

A utility design CAD file must be submitted to AE Design on all projects unless otherwise specified by Design. AE realizes that some smaller projects may not be drawn with CAD software. This submittal is not required if CAD data is not available. It should be recognized that the AE design process would be more efficient with the CAD file versus AE Design having to manually digitize features to complete the work.

A utility design CAD file is an AutoCAD-compatible (DXF or DWG file format) digital drawing file that

contains specific point, line and text objects related to the design and analysis of existing and/or proposed utility lines in the proposed land development. The file contains electronic features data needed to do a CAD-based system design. The utility design CAD file includes the features from the site plan or site/utility plans. This process enables AE Design to provide a more efficient design process for each site development Customer.

The submitted CAD file shall be a DXF or DWG format file containing all of the applicable feature elements listed in Table 1.4.3.3.A. All required objects must be in model space. All files must have the UCS setting to "World". All files must be drawn to scale. The CAD file shall be georeferenced with a coordinate system of NAD 83 Texas Central Zone 4203. The utility design CAD file shall be complete, not be reliant on XREF files contained in other drawing files. (All xref files should be individually imported and attached to a base file before sending to AE). The features shall be placed on separate layers. Refer to Table 1.4.3.3.B for required objects that AE must see on the electronic file and layer recommendations.

Refer to Tables 1.4.3.A & 1.4.3.B below for the list of minimum information and features that AE requires to be shown on the CAD plans.

TABLE 1.4.3.A OBJECTS AND DATA REQUIREMENTS FOR CAD FILES		
Objects & Data Features	CAD Layer Name	CAD Layer Color
Lot Lines	Background	8
Property Lines	Prop Line	Blue
All Easements	Easements	Red
Sidewalks	Sidewalks	9
Driveways	Background	8
Water Lines	Water	144
Water Valves, FH, etc...	Water	144
Waste Water Lines	W	60
Waste Water Valves & etc...	WW	60
Storm Sewer Lines	SD	200
Storm Inlets, etc...	SD	200
Storm Drain Lines	SD	200
Gas Lines	Gas	30
Electric UG Lines	Elec UG	Magenta
Electric OH Lines	Elec OH	Magenta
Electric Manholes, Pull-boxes	Elec MH	Magenta
Electric OH Transformers	Elec Transf OH	Magenta
Electric UG Transformers	Elec Transf UG	Magenta
Electric Poles	Elec Pole	Magenta
Topo Contours Lines	Topo	31
BOC	BOC	8
FOC	FOC	8
Bldgs, existing	Bldg, Exist	8
Bldgs, proposed	Bldg, Prop	40

Trees	Trees	Green
Dimensions	Dims	Blue
Street Names	Text	White
Lot Numbers	Text	White
Fence	Fence	8
Dumpsters	Background	8

TABLE 1.4.3.B REQUIRED FEATURES, OBJECTS, AND DATA TO BE REFLECTED ON THE SET OF HARDCOPY PLANS	
▪ Site plan	▪ Utility profiles (if applicable)
▪ Driveways	▪ One-Line Diagram of the electrical riser
▪ Back & Front of Curb	▪ All floor plans
▪ Existing Buildings	▪ All electrical plans
▪ Proposed Buildings	▪ Engineer Contact Info
▪ All Utilities	▪ Elevations
▪ Location Map	▪ Landscaping
▪ North Arrows	

1.4.2.7 Summary of Basic Processes with Approximate Time Requirements

- A. The Customer should submit an ESPA to AE Design Intake for approval as soon as practical (normally after the DSD approves the site plan). The customer must resubmit the ESPA to AE Design to request service after receiving an Electric Permit number (See Sections 1.4.2.3 and 1.4.2.4). AE Design will require the site plan in a CAD file (See Section 1.4.2.6), a load analysis, a proposed project schedule, a proposed service need date, and a project contact person.

- B. Service Required/Service Need Date. These terms refer to the date that the Customer requests electric service from AE. AE's ability to meet this date is always dependent upon the customer paying all costs and completing all the necessary AE requirements, permits, and inspections with enough lead-time prior to the need date to allow time for AE scheduling and construction. When the project is ready for scheduling, a more realistic construction start time and completion date for the service installation can be determined.

NOTE: Scheduling places the project in the queue of work to be done and begins the process of ordering the materials from AE stores. Once a construction crew becomes available and the project is assigned, the actual time for construction depends on such things as the size and complexity of the project and the weather.

AE will not schedule the job until all the Customer requirements have been completed. Contact AE Design for approximate lead-time and construction-time information for Customer planning purposes. Again, all cost, permits, easements, inspections, all AE requirements, and all other requirements must be completed before the project will be scheduled.

- C. Application for electric service to set up an account with AE is the responsibility of the customer and is part of the requirements that must be completed before the project is scheduled. The application process can normally be completed in one day. Contact the AE Call Center.
- D. For smaller projects and in instances where most of the AE system infrastructure is already in place, the actual design/construction process can normally be completed in two to six weeks after AE Design has received a completed ESPA form with an Electric Permit number and with all of the required Customer and electrical load information. Projects requiring additional infrastructure (such as poles), major equipment (such as a three-phase transformer or switchgear), or other special requirements will take longer. Contact AE Design.
- E. The ordering and delivery time for major equipment such as steel or concrete poles, transformers, and switchgear may take fourteen to twenty-four weeks. The time required to provide service may depend upon what equipment AE has in stock and what must be ordered and therefore may vary from project to project. Contact AE Design.
- F. The Customer's electrical contractor is normally responsible for requesting electrical/civil inspections from the COA Development Services Department Building Inspections division and civil work inspections from AE Work Management. The COA's DSD Building Inspections division is responsible for inspecting the wiring and civil work on the Customer's side of the meter. Electrical Inspections require at least one working day advance notice for each inspection. Generally, a total of 10 to 12 inspections are required by the COA DSD Building Inspections division over the course of a project. Each inspection can usually be completed in one day. Inspection failures will require a re-inspection.
- G. AE Work Management civil inspections of Customer-installed civil work (conduit and concrete pads) for AE facilities for underground installations will usually involve three inspections. Each inspection requires one working day advance notice. The inspection will generally take from one to two hours to complete. Transformer, switchgear, and other equipment pads must cure for seven days prior to the transformer or equipment being installed. (See Distributed Generation Interconnection section for additional distributed generation inspection requirements.)
- H. Inspections by the AE Distribution Metering Operations business unit may take up to five business days to inspect the service when scheduled through the AE Distribution Metering Dispatch Office.
- I. Austin Energy must obtain an easement any time AE installs primary voltage facilities on the Customer's property or secondary voltage facilities that serve more than one Customer (see Section 1.3.6).

1.4.3 COA Development Services Department Building Inspections

For information regarding installation and inspection requirements for the Customer's electrical facilities served by AE and located beyond the AE point of service, call the COA DSD Building Inspections division.

1.4.4 Electric Permits for AE Electric Service within City of Austin

All AE-metered Customers must obtain an electric permit from the COA Building Permits (Service Center) before starting an electrical installation or modification. AE must receive notification from the COA DSD Building Inspections division that the Customer's electrical installation has passed 304 Temporary and/or 305 Final electrical inspection before the AE service is installed, modified, or energized (see Section 1.4.3).

1.4.5 Electric Permits for AE Electric Service Outside of City of Austin

For AE-metered installations located outside of the COA, the Customer must still obtain an electric permit from the COA Building Permits (Service Center) (and a COA electrical inspection) for the Customer's facilities up to and including the main disconnect in addition to those permits required by other regulating bodies. AE must receive notification from the COA DSD Building Inspections division (and other regulating bodies) that the Customer's electrical installation has passed final electrical inspection before the AE service is installed, modified, or energized (see Section 1.4.3).

1.4.6 Coordinating Outages for Installation of New Services

Where installation(s) of a new service require an outage for customers on the same service, the requester of the new service must determine the available outage times from Austin Energy and coordinate the outage schedule with the other customers on the same service.

1.5.0 TYPES OF PERMANENT ELECTRIC DISTRIBUTION SERVICE

Section 1.5.0 provides specific requirements and information for electric service in the Network Area (1.5.1) and for overhead and underground Commercial (1.5.2) and Residential (1.5.3) electric service in all other areas. (See –1.18.0 Appendix and Exhibits for examples of various AE metering and service requirements.)

NOTES: Only copper conductors are acceptable with a maximum size of 500 kcmil. No parallel conductors are permitted for services rated 400 amps or less.

1.5.1 Network Service

1.5.1.1 Underground and Vault Service Only

AE provides only underground and vault service for new customer requests in the Network Area in accordance with the Austin Energy Network Construction Standards. Contact the Network Design business unit concerning the requirements for electric service in the AE Network Area (See Section 1.11.15 for AE Network Area Map).

1.5.1.2 Available Network Service

- A. Electric service is available in the AE Network Area as follows in Table 1.5.1.2, but not all voltages or ampacities are available at all locations. Contact the AE Network Design Section for information concerning the availability of specific voltage and power requirements at a specific location.

TABLE 1.5.1.2 AVAILABLE NETWORK AREA ONLY ELECTRIC SERVICE VOLTAGES AND DEMAND AMPACITIES								
VOLTAGE	SERVICE SIZE (Total connected undiversified demand amps) [6]							
	RESIDENTIAL				COMMERCIAL			
	Secondary Riser		Underground		Secondary Riser		Underground	
	min	max	min	Max	min	max	min	max
120/208V, single-phase, 3-Wire [4]	[1]	200	[1]	200	[1]	200	[1]	200
120/208V, three-phase, 4-Wire [4]	[1]	800[1]	[5]	60 800 [1][2]	[1]	60 800 [1]	[5]	60 800 [2][3]
277/480V, three-phase, 4-Wire	N/A	N/A	N/A	N/A	[1]	[1]	[1]	[1]

- [1] Contact Network Design.
- [2] 800 amps of demand ampacity is not available at all locations. Contact Network Design.
- [3] Contact Network Design for larger service size.
- [4] Where existing facilities are currently available. Contact Network Design.
- [5] AE may elect to furnish this type of service to Customers that do not meet the minimum requirement; however, the Customer shall be required to pay AE for all additional costs and expenses incurred by AE to provide such service.
- [6] CAUTION: Customer's service entrance size shall not exceed the sum of the Customer's total connected *undiversified* load and only copper conductors are acceptable. The service entrance size shall be determined by the nameplate rating of the Customer's main disconnect.

- B. See the following sections for additional network service details:
 1. 1.5.1.4 Underground 208Y/120V Network Service - Residential
 2. 1.5.1.5 Underground 208Y/120V Network Service - Commercial
 3. 1.5.1.6 Network Transformer Vault Service
 4. 1.5.2.5 Underground Secondary Voltage Service from Secondary Riser - Commercial
 5. 1.5.3.4.B Underground Residential Service from a Secondary Riser

1.5.1.3 Existing Overhead Service - RESIDENTIAL AND COMMERCIAL

- A. **Network Area.** Any existing overhead AE facilities located within the Network Area that the Customer must have modified shall be converted to underground at the Customer's expense. The Customer is responsible for service modifications to be done on or within Customer's property. AE will be responsible for extending underground service lateral to the point of service. These modifications include any work such as adding load, changing voltages, relocating the service spot, or upgrading an existing service including any associated Customer-installed civil work. An existing overhead service that only needs repair and does not result in any of the modifications noted above may remain overhead.
- B. **Minimum Working Clearances from Energized Overhead Utility Lines.** See section 1.10.0.

- C. For more information and requirements regarding services in the Network Area, contact the Network Design business unit.

1.5.1.4 Underground 208Y/120V Service – RESIDENTIAL

- A. AE maintains a 208Y/120V, 4-wire underground electrical distribution grid in the Network Area (see the geographic map in Section 1.11.5). Customers in this area requiring electrical service of 800 amps or less of electric service demand might be served from this electrical grid. (The Network Design business unit will determine actual service capacity available). The majority of these service connections will be routed to Customers from the nearest electrical distribution grid access points, which are located in the alleys and streets of the service area shown in Section 1.11.5. See Table 1.5.1.2 for electric service available in this area.
- B. Any new service that falls within the Network Area must be installed underground. The Customer shall furnish and install conduit and necessary conductors from the junction box, main switch, or metering enclosure to the point of service as determined by AE Network Design. The Customer shall leave a 36-inch-minimum copper conductor tail extending from the top of the service box or pull-box.

The Network Design business unit shall specify an exact length of copper conductor tails for manholes and transformer vaults. AE shall make all necessary terminations between the Customer's and AE's copper conductors.

NOTE: Customer is not permitted to access AE pull-boxes or manholes. Contact AE Network Design to schedule assistance when installing the service conductors.

- C. For any new underground installation by the Customer, AE Civil Inspection business unit must complete an inspection of the Customer-installed civil work before the excavation is backfilled. Above-grade conduit installed by Customer is only allowed as a vertical riser from grade to the AE metering equipment and shall be rigid metal or schedule 80 PVC.
- D. Customer shall contact the AE Distribution Metering Operations or Inspections to request the Spot location of metering equipment and other metering and meter location information.
- E. Neutral copper conductors of 3-phase, 4-wire wye-connected services shall have the full-current-carrying capacity of the largest energized conductor from the Customer's point of service to the Customer's service disconnect(s) at the service equipment. The neutral copper conductor must be properly marked and grounded.

For more information and requirements regarding services in the Network Area, contact the Network Design business unit.

1.5.1.5 Underground 208Y/120V Service – COMMERCIAL

- A. AE maintains a 208Y/120V, 4-wire underground electrical distribution grid in the Network Area (see the geographic map in Section 1.11.5). Customers in this area requiring electrical service 800 amps or less of electric service demand might be attached to this electrical grid if capacity is available as determined by the Network Design business unit. The majority of these service connections will be routed to Customers from the nearest electrical distribution grid access points which are located

in the alleys and streets of the service area shown in Section 1.11.5. See Table 1.5.1.2 for electric service available in this area.

- B. Customers requiring electrical service above 800 amps (208Y/120V, 4-wire) must provide a network transformer vault on the Customer's property, at the Customer's expense, as specified by the Network Design business unit.
- C. Any new service that falls within the Network Area must be installed underground. The Customer shall furnish and install all civil work, according to Network Design specifications, from Customer point of service to AE's pull-box, manhole or electrical vault. When the conduit is required to be installed into an existing pull-box, manhole or electrical vault, the conduit shall be stubbed within 12 inches of AE's facility. AE shall be responsible for installing all conduits into the AE pull-box, manhole or electrical vault. The Customer shall furnish, install, own, and maintain the necessary copper conductors from the service location to AE's pull-box, service box, manhole or vault. The Network Design business unit shall specify this location.
- D. The Customer shall furnish enough copper conductor length to extend out of the top of the service box or pull-box to a minimum of 36 inches above the lid. The Network Design business unit shall specify an exact length of copper conductor tails for manholes and transformer vaults. AE shall make all necessary terminations between the Customer's and AE's conductors.
- E. For any new underground installation by the Customer, AE Civil Inspection business unit must complete an inspection of the Customer-installed civil work before the excavation is backfilled. Above-grade conduit installed by Customer is only allowed as a vertical riser from grade to the AE metering equipment and shall be rigid metal or schedule 80 PVC.
- F. Customer shall contact the Austin Energy Metering business unit to request the spot location of metering equipment and other metering and meter location information.
- G. Neutral conductors for three-phase, 4-wire wye-connected services shall have the full-current-carrying capacity of the largest energized conductor from the Customer's point of service to the Customer's service disconnect(s) at the service equipment. The neutral conductor must be properly marked and bonded.
- H. For more information and requirements regarding services in the Network Area, contact the Network Design business unit.
- I. Service conductors must be consistent in size, type (copper or aluminum) throughout the metering equipment. If the meter is not located at the point of service where the customer conductors are connected to AE facilities (i.e., AE Transformer) there must be no splices, connections, or customer-accessible enclosures between the point of service and the meter. The outlet, device, cutout, pull or junction boxes, cabinets, wireways, gutters, conduit bodies (such as, condulets-LB, LL, LR) or any other apparatus that is designed and intended to allow access to conductors shall not be allowed ahead of metering equipment.

1.5.1.6 Network Transformer Vault Service

Network transformer vault service is necessitated by the Customer's requested electrical load and/or requested service voltage. A network transformer vault shall be located on the Customer's property and shall conform to the following conditions:

- A. Where the Customer's total electrical demand load per AE's determination exceeds (800 amps) for a 208Y/120V three-phase service and for any size 480Y/277V three-phase service, the Customer shall provide a transformer vault according to AE specifications and requirements. The vault structure shall conform to Section 1.11.0 of this Design Criteria (plus any additional requirements by AE Network Design). The transformer vault shall be located on the Customer's property and at or closest to the property line adjacent to AE's underground primary facilities either at grade level or sub-grade provided the Customer can meet all required conditions in Section 1.11.0 of this Design Criterion. All Network transformer vaults shall be located a minimum of 2 feet above the 100- year floodplain.
- B. The Customer shall contact the Network Design business unit before any vault design work is started. See Section 1.11.0 for additional design information and requirements.
- C. The Customer shall furnish and install conduit from the vault to a location designated by AE Network Design business unit.
- D. AE shall own and maintain the conduit from its facilities to the Customer's property line. AE shall furnish, install, own, and maintain the primary cables from its facilities into the vault. AE shall furnish, install, own, and maintain the necessary transformers and equipment in the vault and do all work inside the vault.
- E. The Customer shall extend bus duct — as specified by the Network Design business unit — into the vault. Bus duct, typically no more than two, must enter the vault with spacing on 12- inch centers between the phases. The spacing between the bus ducts will be determined by the Network Design business unit. All bus duct entries, including any future bus duct entries, must be included during the original installation. No additional service entries will be allowed after original installation.
- F. AE shall maintain all AE electrical facilities from AE's manhole to the connection at the Customer's service conductors. This does not include the building/vault structure, doors, louvers, vents, and conduit system that is on the Customer's property.
- G. AE shall keep the vault locked at all times but shall provide the Customer access to the vault upon request. (Please contact the Network Design business unit to schedule time for access and to determine any charges to the Customer.) AE must have outside personnel entry to the vault that is immediate and unabated at all times.
- H. The transformer vault shall contain only the AE power transformers and AE auxiliary equipment. The vault shall not contain meters or any Customer switches, protective equipment, fiber or any fiber optics, telephone, or security system hardware not specifically required by AE. The Customer shall not have a sprinkler system or other fire extinguishing system installed in the vault. AE recommends that the Customer locate his electrical service equipment immediately adjacent to the vault.
- I. Customer shall contact the AE Distribution Metering business unit to request the spot

location of metering equipment and other metering and meter location information.

1.5.1.7 Inspections of Customer-Installed Civil Work in the Network Area

- A. Customer shall contact the AE Civil Inspection business unit and the Network Design business unit for the preconstruction meeting for the final inspection of all Customer-installed civil work for projects in the Network Area. (AE Network Design will inspect Customer-installed network vaults).
- B. For more information and requirements regarding services in the Network Area, contact the Network Design business unit.

1.5.2 COMMERCIAL Service in Non-Network Areas

(See Sections 1.3.0 and 1.4.0.)

1.5.2.1 General Conditions and Requirements - Commercial

- A. **Prior to Electrical Installation.** Before starting work on any new or upgraded electric service, the Customer shall ensure the land is a legal lot or tract as required under the Land Development Code.
- B. **Contact AE Design or AE Spots & Conduit.** (See Section 1.4.1) In order to facilitate electric service availability when needed, the Customer should discuss all electrical service issues with AE Design well in advance of the desired service date to determine the requirements and time frame for providing electric service. Necessary information that should be included in the ESPA includes exact location of the property to be served, such as street address, lot and block number of subdivisions, service voltage, equipment characteristics, connected load, and the size of the service entrance equipment including equipment ratings and the size and number of service entrance conductors.
- C. **Service Availability.** Not all standard AE service voltages are available at all locations. If the available service does not meet the Customer's requirements as requested in the ESPA, AE may agree to supply the type of electric service Customer requires at an additional cost to the Customer if the request meets the following conditions:
 - 1. The request is feasible as determined by AE Design.
 - 2. The Customer's equipment and/or the manner of use does not jeopardize the quality of service to other AE Customers or the reliability of the AE system as determined by AE Design.
- D. **Costs to the Customer.** The Customer may be required to pay AE a line extension charge and/or an excess facilities/excess costs charge (see Section 1.3.0). AE Design will determine if either or both of these charges are applicable.
- E. **Service Location/Property Address.** Before the installation of the temporary meter loop or approval of ESPA, the property address must be located at the service location site so that it is visible from public right of way and have this address clearly marked on the meter loop, meter pole, and/or meter pole braces (See Section 1.7.0). The property address must remain visible continuously during the design and construction phase and after completion of the project. Note: The property address includes ½ identifier address for all commercial temporary and (or) construction power loops

(unless transformer will be used for permanent service.

- F. **Agreement for Underground Electric Service (Letter of Agreement).** The conditions (and costs) under which underground electric service is supplied to a Customer shall be covered by an "Agreement for Electric Service" letter provided by AE Design.

IMPORTANT: The Agreement for Electric Service by AE to serve a particular installation underground applies only to the specified wiring and equipment at the Customer-specified location as given in the ESPA. The Customer shall notify AE Design as soon as possible whenever any change in an installation is contemplated so that proper provisions may be made for adequate service connections and metering facilities.

- G. **Commercial Service Ownership.** AE normally installs, owns, and maintains the overhead service drop from AE facilities to the Customer's facilities. The Customer normally installs, owns, and maintains the underground service lateral from the point of service, which is usually a pull-box/service-box or an AE pad-mounted transformer (as designated by AE Design) to the Customer's building or facility. Two or more meters must be grouped together and have the pull box as the point of service (POS).
- H. **Main Disconnect Switches.** The Customer's main disconnect switch(es) shall be in accordance with Austin City Code, Chapter 25-12.
- I. **Permanent Overhead Service.** The Customer's overhead service drop that is not installed to a permanent building or structure shall be installed on a rack that is constructed of non-corrosive metal and supported by galvanized rigid steel 4-inch minimum diameter or a 6" x 6" pressure treated pole/post. The poles/posts shall be installed a minimum of 3 feet deep encased in concrete. Rack shall be installed permanently with sufficient bracing and shall be stationary.

For Customer services requiring meter bases rated over 350 amps, the pole or rack must be engineered, and a drawing provided to AE Design confirming that the structure will support the AE overhead service tension. AE Design will provide the pole/structure loading requirements for the overhead service.

- J. **The Customer-Installed Civil Work.** (conduit and so forth) required for the *Customer-owned permanent underground service lateral that is located on the source side of the AE meter* shall also meet the requirements of AE Design and this Design Criteria.
- K. **AE Responsibility for Customer-Installed, Owned, and Maintained Facilities.** AE ASSUMES NO RESPONSIBILITY FOR ANY PORTION OF THE CUSTOMER'S INSTALLATION. AE reserves the right to discontinue or refuse service to any apparatus or device under the following circumstances:
1. Apparatus or device is not properly constructed, controlled, or protected.
 2. The Customer has not provided the necessary easements or obtained the required inspections and permits.
 3. It is determined at AE's discretion that the apparatus or device has the potential to adversely affect AE facilities or other AE Customers or is determined to be unsafe.

- L. **Placement of Customer's Facilities.** The Customer's service shall not be installed on facilities owned by AE (such as AE's pole or padmount transformer). The Customer should be aware of AE overhead and underground electric facilities and their easements. The Customer's facilities, including, but not limited to buildings, signs, swimming pools, spas, decks, carports, garages, equipment or any other structure shall not be installed over or under these electric facilities or in an easement unless written approval is obtained from AE. For information, contact AE Design.
- M. **Commercial Meter Loop Location or Replacement.** Meter loops shall not be installed on manufactured, portable buildings, or similar structures that are not legally a permanent part of the property (except as approved by AE Design). An electric permit will be required, and meter loop must be upgraded according to current codes whenever there is a need to replace a meter loop pole (such as replacing a rotten pole). Meters may be mounted on Modular structures if the customer provides Austin Energy with the necessary paperwork indicating the structure is built and inspected by Texas Department of Licensing and Regulation (TDLR) and paperwork is on file and attached to the electric or building permit.

AE Design (or AE Spots & Conduit for 'service only' residential and small commercial) shall designate all AE non-CT point of attachment locations with the concurrence of AE Distribution Metering Operations. The meter location(s) should be on the first floor or ground level. AE Design must approve meter location exceptions in writing for underground Customer- installed and -owned service installations NOT metered at the transformer, the meter(s) shall not be located more than 150 feet from the point of service. The service lateral shall not be installed under any building or other structure.

- N. **Fire Pumps.** Electric service to fire pumps shall be served through a CT-metered service.
- O. Service conductors must be consistent in size, type (copper or aluminum) throughout the metering equipment. If the meter is not located at the point of service where the customer conductors are connected to AE facilities (i.e., AE Transformer) there must be no splices, connections, or customer-accessible enclosures between the point of service and the meter. The outlet, device, cutout, pull or junction boxes, cabinets, wireways, gutters, conduit bodies (such as, condulets-LB, LL, LR) or any other apparatus that is designed and intended to allow access to conductors shall not be allowed ahead of metering equipment.
- P. **Grounding and Bonding of Customer-installed Electric Services.** Electric services, including, but not limited to, service equipment, raceways, service distribution enclosures, junction boxes, wire-ways, enclosures, and any service conductor to be grounded/bonded, shall be grounded/bonded in accordance with the latest edition of the NEC.

EXCEPTION: The grounding/bonding conductors for all services shall be copper only, with a minimum size of #6 AWG copper.
- Q. **Primary Dual Feed Services.** Customers requesting primary dual feeds shall contact Austin Energy Key Accounts. The Customer will be provided the allowable options and requirements available from Austin Energy for dual feed types of services.

1.5.2.2 Available Commercial Electric Service

Commercial electric service available in the AE service area is as follows in Table 1.5.2.2 but not all voltages or ampacities are available at all locations.

TABLE 1.5.2.2 [See Note 9]						
VOLTAGE [7]	Maximum Available Demand Load (amps)					
	<i>Overhead</i>		<i>Secondary Riser</i>		<i>Underground</i>	
	min	max	min	max	min	max
120/240V, 1PH, 3-Wire		800 [3]		800 [3]		800 [3]
120/240V, 3PH, 4-Wire [3]	100 [2]	800 [3]	100 [2]	800 [3]	[1]	[2]
120/208V, 3PH, 4-Wire	300 [2]	1600 [3]	300 [2]	1200 [3]	300 [2]	2200 [3]
277/480V, 3PH, 4-Wire	300 [2]	600 [3]	300 [2]	600 [3]	300 [2]	3000 [3]
7200/12470V, 3PH, 4-Wire [6]	15	100 [3]	NA	NA	15	100 [3]

[1] Typically available only from the overhead distribution system. Contact AE Design.

[2] AE may elect to furnish larger service than is required (by AE's calculation) to the Customer at a single point of service at the Customer's request. However, the Customer shall be required to split their secondary voltage bus or pay AE for all additional costs and expenses incurred by AE to provide such service. Contact AE Design.

[3] 750 kcmil is the maximum wire size allowed.

[4] For the purpose of sizing AE facilities, AE Design shall determine the maximum expected Customer demand load that will be seen by AE facilities from the Customer's total connected undiversified load information and business type as documented on the ESPA form. AE facilities will be sized by AE Design accordingly. The maximum demand load amp service available from AE is defined in Table 1.5.2.2.

[5] Prior to installing equipment and phase marking, the Customer shall contact AE design for information regarding proper AE phase rotation at the location to be provided service. Customer, and not AE, shall be responsible for any improper service installation due to incorrect phasing rotation.

1.5.2.3 Overhead Secondary Voltage Service - Commercial

A. Service-Drop Conductors

1. *General.* For service-drop conductors, furnished and installed by AE that connect AE's supply lines to the service conductors provided by the Customer, the point of service is the point at which AE's and the Customer's conductors are connected at the weatherhead(s) and one-point rack(s) location. AE shall make all connections of AE conductors at the point of service.
2. Service conductors must be consistent in size, type (copper or aluminum) throughout the metering equipment. If the meter is not located at the point of service where the customer conductors are connected to AE facilities (i.e., AE Transformer) there must be no splices, connections, or customer-accessible enclosures between the point of service and the meter. The outlet, device, cutout,

pull or junction boxes, cabinets, wireways, gutters, conduit bodies (such as, condulets–LB, LL, LR) or any other apparatus that is designed and intended to allow access to conductors shall not be allowed ahead of metering equipment.

3. *Clearances/Attachment Heights.* NESC (Section 23) along with AE Design/Construction require minimum clearances for service-drop conductors from final grade or other accessible surfaces, which shall be maintained at all times. To facilitate these clearances, minimum and maximum attachment heights shall be as listed in Table 1.5.2.3.A.

TABLE 1.5.2.3.A			
CLEARANCES AND ATTACHMENT HEIGHTS FOR SERVICE-DROP CONDUCTORS			
COMMERCIAL SERVICES			
	Minimum Clearance From Final Grade Other Accessible Surface (Feet)	Attachment Height	
		Minimum (Feet)	Maximum (Feet)
Services passing over driveways, or parking lots and alleys (not subject to truck traffic). Commercial services over areas accessible to pedestrians only.	16	16	18
Services passing over roads, streets, alleys, parking lots, subject to truck traffic or other land traversed by vehicles such as cultivated forest, and orchard.	18	18	21
A minimum clearance above the roof of 18 inches to mast shall be permitted for service mast installations, including, but not limited to service-mast (through-the-roof) installations where the voltage between conductors does not exceed 300V and the roof is sloped no more than 4 inches in 12 inches. Services exceeding 300V require a minimum clearance of 8 feet.			
Where the voltage between conductors does not exceed 300V and the mast is located within 4 feet of the edge of the roof and above only the overhanging portion of the roof, a minimum clearance of 18 inches shall be permitted for service-mast (through-the-roof) installation. No more than 10 feet of service-drop conductors may pass above the roof overhang. Services exceeding 300V require a minimum clearance of 8 feet.			

4. The Customer is responsible for *tree trimming* activities prior to the installation of AE facilities to allow the safe installation of electrical facilities by AE as determined by AE Design.
5. All clearances shall comply with rules/exceptions as stated in the NESC in addition to the following:
 - a. Where physical features, such as terrain or vegetation are unusual, additional

attachment height may be required to allow for conductor sag.

- b. Service Mast (Supporting/Through Roof): Service mast must be a minimum 2-inch Intermediate Metal Conduit. Service mast through the roof and over 4 feet from strapping or supports must be guyed within 3 inches of the point of attachment. The one-point rack may be attached to service mast, provided the service mast is supporting and through the roof. When one-point rack(s) is attached to service mast, no fittings, such as couplings, may be located between the roof and point of attachment.
- c. Service Mast (Non-supporting/Not-Through-Roof): Service mast must be Rigid Metal, Intermediate Metal, or EMT conduit. The one-point rack may **not** be attached to a non-supporting/not-through-roof service mast.
- d. A maximum length of 6 feet of service-drop conductors may pass over the roof of the building or structure being served, regardless of the height above and/or the slope of the roof.

EXCEPTION: A maximum of 10 feet of service-drop conductors may pass over the roof of the building or structure to which the service-drop is not attached, regardless of required height above the roof and/or slope of the roof when the service drop meets all the following conditions:

- The building or structure is on the same piece of property and owned by the same Customer as the building being served to which the service-drop is attached (such as a garage or storage building)
 - The voltage between the service-drop conductors does not exceed 300 volts
- e. Service-drop conductors shall not pass within 7.5 feet, measured horizontally, or over or under any portion of a building or structure to provide service to another building or structure except as allowed in this Design Criteria. Additional clearances may be required as indicated in Section 23 of the NESC.
 - f. Service-drop conductors shall not pass within 7.5 feet, measured horizontally, or over or under signs, chimneys, billboards, radio and television antennas, tanks, streetlights, and other installations not classified as buildings. Additional clearances may be required as indicated in Section 23 of the NESC.
 - g. For more information, contact AE Design.

HIGHLY RECOMMENDED: For safety reasons, the customer should contact AE to have the electric power de-energized before working near AE facilities.

6. *Anchorage of Overhead Service-Drop Conductors*

- a. The Customer shall provide (1) an adequate anchorage for the service-drop conductors, using a one-point rack(s) and (2) a suitable location for AE's metering equipment. Customer shall install and maintain the one-point rack(s).

- b. For services rated 800 amps or less, a single one-point rack shall be used for 3-wire and 4-wire. The rack shall be installed within 12 inches below the weatherhead at the required attachment height.

For services rated over 800 amps, three one-point racks shall be installed for 3-wire services and four one-point racks for 4-wire services. The racks shall be installed 10 to 12 inches apart, measured center to center.

Factory-assembled racks are allowed, as approved by AE Design. The Customer shall furnish, install, own, and maintain these racks.

Multiple racks installed *horizontally* shall be installed a maximum of 12 inches below the weatherhead(s) at the required attachment height. The center point of the racks shall be directly below the weatherhead(s).

Multiple racks installed *vertically* shall be installed with the highest rack within 12 inches below the weatherhead and the lowest rack at the required attachment height.

- c. The service-drop conductors shall be attached to a permanent building or structure *at the point of attachment designated by AE* - usually a location closest to AE's nearest facilities/pole. The Spot & Conduit business unit or AE Design shall determine the point of attachment on the Customer's building or structure.
- d. In order to provide adequate support for the service, the Customer shall use a minimum 1/2-inch diameter threaded bolt with nut and washers to securely attach the one-point rack(s) dead-end attachment securely to the structural frame of the building. On a wood frame structure, the Customer shall provide a securely attached minimum 2-inch x 4-inch header for this purpose.

Meter sockets and service entrance to the point of service are not considered complete until the one-point rack(s) has been properly installed.

- e. Wherever the building height does not permit the required clearances for the service-drop conductors, the Customer shall provide approved permanent metal service supports (see 1.5.2.1.I).
- f. Existing overhead service supply conductors where raised solar panels are installed must maintain minimum clearance of 6' above solar panels.

- B. **Service Drop Lengths.** For either permanent or temporary services, the Customer's service entrance facilities (such as service equipment, service conductors, or one-point rack) shall be installed relative to the service drop length according to the following (see section 1.10.6):

10-foot minimum	Regardless of service size: service drop length measured horizontally and perpendicular to AE's facilities (poles and overhead lines) (Also see Section 1.10.6.1.)
75-foot maximum	For service entrance equipment rated 225 amps or less: service drop length measured horizontally/radially, from AE's facilities (pole serving Customer's facilities)
55-foot maximum	For service entrance equipment rated over 225 amps but 350 amps or less: service drop length measured horizontally/radially from AE's facilities (pole serving Customer's facilities)
Contact AE Design	For service entrance equipment rated more than 350 amps

All other maximum service lengths shall be specified by AE Design. Point of attachment must be able to withstand 400 pounds of tension.

C. **Service Head (Weatherhead)**

1. *Customer's Service Conductors.* To permit connection with AE's service-drop conductors, the Customer's service conductors must extend as follows according to the wire size:

#6 AWG through #1/0 AWG	18-inch minimum plus the distance from the service head to the rack
#2/0 AWG and larger	36-inch minimum plus the distance from the service head to the rack

If these conductor lengths are not provided, the CUSTOMER must rewire to meet the requirement.

2. *The service head shall be approved weatherproof construction and installed to prevent the entrance of rain. The service head shall terminate within 12 inches above the one- point rack on the building, where the structure will permit.*
3. *For multiple service head, Customer service conductors shall reach the rack(s) on the building (plus 36 inches). Each service weatherhead shall have a full-current neutral. AE SHALL CONNECT THE CUSTOMER'S CONDUCTORS WITH AE'S SERVICE-DROP CONDUCTORS. No more than six service conductors per phase will be connected at the point of service.*

1.5.2.4 Customer-installed Underground Services and Civil Work

A. Primary and Secondary Conduit, Pull-Boxes/Manholes, and Equipment Pads for AE Infrastructure

1. Underground primary and secondary infrastructure (conduit, pull-boxes/manholes, and equipment pads) installed on the source side (ahead) of the point of service for AE electrical facilities shall be installed *with respect to final grade* in utility easements or easements granted to AE. They shall not be installed under or permitted to pass under or through buildings or structures, including, but not limited to, such things as porches, stairways, decks, garages, or storage buildings.
2. All primary and secondary underground infrastructure in which AE installs AE conductors, shall be rigid metal or schedule 80 PVC where conduit is installed in backfill, and minimum schedule 40 PVC when encased in concrete. The conduit shall be limited to a maximum of two 90-degree bends (180-degrees total) between accessible pulling points (for example, transformer and pull-box). No heated bends are permitted.

Primary conduit shall be installed a minimum of 30 inches deep and the secondary conduit shall be installed a minimum of 24 inches deep, measured to the top of the conduit from the final grade.

NOTE: All conduit installed crossing COA streets or installed in the COA public right of way shall be a minimum of 36 inches deep measured to the top of the concrete encasement/cap or the conduit if other backfill.

Only communication cables are allowed in the same trench with AE facility conduits and shall be installed a minimum of 6 inches above and to the side of the top electrical conduit. Communication conduits are not allowed over AE main line duct banks (see main line definition in glossary.) (Primary and secondary risers shall be approved rigid metal.) For more information, contact AE Design.

3. When the civil work for AE facilities (or any service conduit ahead of the AE meter) has been installed, inspected, and approved by AE, the final grade shall not be changed by any excavation, filling, landscaping, or sodding without the prior written approval of AE (see Section 1.10.10).
4. AE Design will specify requirements for pull-boxes, manholes, equipment pads, and such.
5. All conduits shall slope away from electrical equipment.
6. Contact the AE Work Management business unit or AE Civil Inspection business unit for an on-site preconstruction review with AE inspector(s) of the proposed Customer-installed civil work installation.

B. Customer Installed, Owned, and Maintained Underground Service and Service Laterals

1. **COA DSD Building Inspections** division must inspect the Customer-installed and owned service lateral conductors and the Customer-owned electrical service equipment. AE must inspect the service lateral conduit on the source side of the AE meter (see Section 1.5.2.4.B.2-7). Customer must install all infrastructure on the load side of the point of service in accordance with the National Electrical Code (NEC) as adopted in City Code and any other applicable City Code requirements.
 2. The Customer-installed service lateral conduit installed on the source side of the AE meter shall be run from the AE energy supply point to the closest point on the Customer's building or structure or equidistant (as designated by AE Design or AE Spots & Conduit) to a rack or pedestal (pre-approved by AE Design) suitable for mounting the riser conduit and AE meter base.
 3. All exposed conduit at the building/structure must be strapped to the structure and flush with the wall. Conduit must be capped at the riser pipe, especially if it is cut off at the slab, to prevent debris from falling into the conduit. All risers must be cut level with the slab if the masonry or siding is not completed when the conduit inspection is requested. (Conduit inspections will be based upon the load specified on the Electric Permit.)
 4. *Multiple service conductors* that are furnished, installed, owned, and maintained by the Customer and that are serviced by AE from one point of service location shall be grouped.
 5. *Multiple meters* shall be grouped and located on the exterior finished surface of the building or structure at a location approved by AE Design.
 6. Service lateral conductors installed by the Customer ahead of the meter shall be installed as follows:
 - a. No breaks in service wire or conduit are allowed between point of service and the first above-grade enclosure.
 - b. The last 90-degree bend ahead of the first above-grade enclosure (such as service distribution enclosure, junction box, wireway, self-contained meter, transocket, or CT enclosure) shall be one of the following:
 - Rigid Nonmetallic Schedule 80 or Schedule 80 PVC (Electrical PVC- Gray Color) No heated bends are permitted.
 - Ridge Metal (Rigid Galvanized Steel).
- The 90-degree bend(s) should be pointed toward the AE service box, pull-box, or transformer designated by AE Design or AE Spots & Conduit.
7. Conductors, other than service conductors, shall not be installed in the same service raceway with service-entrance cables. (Also, metered and unmetered conductors shall not be installed in a common wireway or gutter.)

EXCEPTION: Grounding and bonding conductors may be installed in the same

raceway.

8. The neutral conductor must be properly marked and bonded.
9. *High-leg Phase Conductors.* Particular attention shall be given to marking high-leg phase conductors feeding from a 3-phase, 4-wire, 120/240V delta secondary source. The high-leg shall be effectively identified in accordance with NEC 230-56 (marked by orange tape).

The high-leg shall always be connected as follows:

In meter sockets, including pre-wired transockets	To the right-hand terminals
In CT enclosures	To either the right-hand CT (left to right), or the bottom CT (top to bottom)
In service equipment	To the center bus

10. *Single-phase installations shall be 3-wire; three-phase installations shall be 4-wire.* Conductor sizes shall conform to the NEC and approved by the COA DSD Building Inspections division. Minimum size service conductors for connection to AE facilities shall be #6 AWG copper or equivalent for commercial permanent services. Maximum size service conductors for connection to AE facilities shall be 750 kcmil.
11. Service conductors must be consistent in size, type (copper or aluminum), and such through the metering equipment. If the meter is not located at the point of service, where the Customer conductors are connected to AE facilities (i.e., AE Transformer), there must be no splices, connections, or Customer-accessible enclosure between the point of service and the meter. Outlet, device, cutout, pull or junction boxes, cabinets, wireways, gutters, conduit bodies (such as, condulets-LB, LL, LR) or any other apparatus that is designed and intended to allow access to conductors shall not be allowed ahead of metering equipment. [

EXCEPTION: Service distribution enclosures. Junction boxes and wireways as permitted for multiple-meter and multiple-disconnect installations in *Service Distribution Enclosures (Tap or "J" Box) and Wireway Specifications* in Section 1.14.0.

EXCEPTION: (From Section 1.3.9) For 277/480V three-phase self-contained meter sockets and for 480V three-phase or for any low voltage secondary voltage service above 300V up to 600V phase to phase or leg to leg, *a service load-break disconnect switch shall be installed in close proximity to and on the line side (ahead) of the metering equipment.* [Line-Disconnect-Meter-Load]

12. All above-grade service conduit shall be exposed and continuous on the exterior-finished surface of the building or structure.

EXCEPTION: The portion of the service mast through the eaves (overhang portion) of the roof is not required to be exposed.

13. When the Customer desires AE to install the meter on the building or structure (rather than taking service at the transformer or service-box/pull-box), AE requires that the Customer-installed, -owned, and -maintained service conduit and service lateral conductors installed ahead of the AE meter(s) not be installed under or through a building or structure, including, but not limited to, porches, stairways, decks, carports, garages.
Should future ordinances or legislation require the AE meter to be the point of service and where the above conditions are not met, the Customer assumes the total responsibility for establishing a master-meter/submeter system or for relocating the service conduit and service lateral conductors so that they are AE-accessible.

1.5.2.5 Underground Secondary Voltage Service from Secondary Riser - Commercial

- A. **General.** In areas where only overhead distribution facilities exist and a customer requests underground service, a secondary riser is a method to provide an underground service to the site. Secondary service voltages are available by means of a secondary riser where the appropriate overhead distribution facilities are available. All underground services from secondary risers must meet electrical demand load conditions outlined in Table 1.5.2.2.

- B. **Customer and AE Commercial Service Installation Responsibilities**

1. *Customer Responsibilities (on the Customer's property)*

- a. If the Customer-installed service lateral conductors are smaller than 500 kcmil or up to two 4/0 AWG per phase, the Customer shall furnish and install, a 36-inch *pull box* (load-bearing or non-load-bearing as specified by AE Design) at the base of the pole. (In some cases, an 18-inch service box may be allowed for 200 amp and smaller service entrances where there is no need to allow for load growth and where the Customer-installed service lateral conductors are no larger than one 1/0 AWG per phase) or

If the maximum Customer-installed service lateral conductors is 500 MCM or more than two 4/0 AWG per phase, the Customer shall furnish and install a 48-inch *pull-box* (load bearing or nonbearing) at the base of the pole as specified by AE Design.

- b. The Customer shall furnish and install stub-up from service box/pull-box to pole and first 10-foot section of *rigid, galvanized* steel riser conduit up the pole. The riser's 90-degree bend with minimum 24-inch radius installed by Customer shall be a rigid metal conduit and encased in concrete. The number and size of riser conduits will be determined by AE Design.
 - c. The Customer shall dig and backfill trench from meter/service location to service box/pull-box. The trench shall be a minimum of 24 inches deep from grade to the top of service conduit.
 - d. The Customer shall furnish and install, the service lateral conduit, approved intermediate metal conduit, or schedule 80 PVC, from the last 90-degree bend with 24-inch minimum bend radius ahead of the meter/service location to service box/pull-box (maximum length of 150 feet). No heated bends are

permitted.

The last 90-degree bend with 24-inch minimum bend radius ahead of the meter and the service riser conduit to the meter shall be approved intermediate metal conduit or schedule 80 PVC.

All service conduits shall be 2-, 3-, 4-, or 5-inch with no half sizes permitted.

HIGHLY RECOMMENDED: Contact the AE Work Management business unit for an on-site preconstruction review with AE inspector of the proposed civil installation.

- e. The Customer shall furnish and install the service conductors from meter/service location into service box/pull-box. The point of service shall be the service box/pull-box or as designated by AE Design. The Customer shall leave a 48-inch minimum conductor tail extending from (out of) the top of the service box or pull-box.

If a bonding conductor is required by the NEC, the Customer shall install the bonding conductor, and AE shall make the necessary connections. THE CUSTOMER SHALL NOT BREAK INTO SERVICE BOX/PULL-BOX WITHOUT AE WRITTEN APPROVAL AFTER AE CONDUCTORS HAVE BEEN INSTALLED except as approved by AE Design or AE Spots and Conduit.

CAUTION: The Customer is not allowed under any circumstances to break into any AE pull-box containing AE primary voltage conductors.

- f. The Customer shall request the following inspections:
 - **AE Work Management** - inspects the service lateral conduit ahead of the AE meter, the box/pull-box, the underground secondary conduit to the pole, the 90-degree bend at the pole, and 10-foot riser conduit extension of intermediate metal conduit up the pole. *AE installs conductors from the pull-box up the pole and makes the connections in the pull-box.*

Contact the AE Work Management business unit (or AE Civil Inspection business unit for Major Project or Network Installations) for an on-site preconstruction review with AE inspector(s) of the proposed Customer-installed civil work installation.

- **COA DSD Building Inspection division** - inspects the Customer-installed service lateral conductors from the service box/pull-box to the meter/ service equipment location.

IMPORTANT: Do not backfill trench or encase 90-degree bend(s) or service conduit until the above inspections by AE have been completed and approved.

2. *AE Responsibilities*

- a. Install upper portion of secondary riser conduit on pole to complete riser.
- b. Install conductors in riser conduit from the pole-mounted transformer(s) into service box/pull-box.
- c. Connect AE conductors with Customer service conductors in service box/pull-box.

1.5.2.6 **Pad-Mounted Transformer Secondary Voltage Service – Commercial**

- A. **General.** Where underground secondary voltage service is provided by means of underground primary voltage cable, pad-mounted transformers, and associated equipment, the Customer will need to provide space on his property and the necessary easements for the required AE underground cable, underground facilities, and pad-mounted equipment. The Customer is required to install the civil work for AE facilities installed on the Customer's property. The Customer must also grant the City an easement on the City's standard form. The pad-mounted transformers and associated equipment must be installed on concrete pads or in transformer vaults (Network area only). All Customer-installed civil work for AE facilities must comply with all provisions of the COA Design Criteria, NESC, NEC, AE Design, and any applicable Specifications, Rules, Regulations, and Conditions. For more information, contact AE Design.
- B. **Metering Equipment.** The metering equipment shall be grouped and located on the exterior finished surface of all buildings. If multiple meters are served from the pad-mount transformer, a service distribution enclosure must be installed on the exterior finished surface of the building or a structure adjacent to the building. The Customer-installed service lateral shall terminate in the service distribution enclosure. (See Section 1.9.0 and 1.18.0 Appendix and Exhibits) For more information, contact AE Design.
- C. **Metering at Three-Phase Pad-Mounted Transformers Only.** When a dedicated three-phase pad-mount transformer serves one Customer and the CT-metering equipment is located in the secondary compartment of the transformer, the transformer secondary compartment shall be considered the point of service.
 1. No other service and no other meter is intended to be served from this pad-mount transformer.
 2. When CT-metering equipment is installed in the secondary compartment of the transformer, the S-1 socket enclosure shall be installed on a rack on a separate pad or an extension of the transformer pad. For alternate meter locations, contact AE Distribution Metering business unit. (See 1.18.0 Appendix, Figure 11)
 3. The conduit from the secondary compartment to the S-1 socket shall be minimum size 1¼ inches and no larger than 1½ inches, either rigid metal conduit or Schedule 80 PVC conduit, with a #6 copper ground installed with at least 4 feet of wire pulled in the secondary compartment for grounding and bonded to the S-1 socket's grounding terminal, and with a pull-string installed.

D. **Underground Installation Responsibilities.** AE will provide a pad-mounted transformer service in accordance with the following outlined conditions. Refer to Table 1.5.2.2.

1. *Customer's Responsibility*

- a. The Customer shall furnish and install the following in accordance with AE plans and specifications as provided by AE Design (based on Customer-furnished AutoCAD site and facility drawings as required by AE Design):
 - Concrete pad for transformer(s)
 - Primary conduit system
 - Secondary conduit system: The number and size of conduits from the secondary compartment of padmount transformer shall be determined by AE Design. Typically, AE single-phase pad-mount transformers can take a maximum of four conductors per leg/neutral. Three-phase pad-mount transformers can take a maximum of ten conductors per phase/neutral. Only one circuit of Customer secondary service conductors can be installed per conduit.
 - Service boxes (18 inches) and pull-boxes (36 inches and 48 inches)
 - Primary riser: pull-box and stub-up from pull-box to pole and first 10-foot section of riser conduit (rigid galvanized steel) up the pole. Riser's 90 bend shall be rigid metal. Underground conduit shall be encased in concrete. Number and size of riser conduits shall be determined by AE Design.
 - Service from the point of service up to and including the service entrance equipment.
- b. The Customer shall extend secondary service conductors to the transformer secondary compartment with sufficient tails to reach the secondary terminals (plus 24 inches).
- c. The CUSTOMER shall contact AE Design to determine the maximum number of conductors per phase that may be stubbed into the secondary compartment of a transformer and to facilitate the pulling of the Customer's conductors into the secondary compartment.
- d. The Customer shall provide an easement on the City's standard form for the transformer pad, other pad-mount equipment, AE primary, and secondary conductors, and associated AE facilities.
- e. The Customer shall request the following inspections: (see 1.5.2.11)
 - **AE Work Management** - The primary cable conduit (30 inches below grade to the top of the conduit), the transformer pad(s), the transformer pad stub-outs of secondary or service lateral conduits, and the service

lateral conduit ahead of the AE meter (24 inches below grade to top of conduit).

Contact the AE Work Management business unit (or AE Civil Inspection business unit for Major Project or Network Installations) for an on-site preconstruction review with AE inspector(s) of the proposed Customer-installed civil work installation.

- **COA Electrical Inspection** – Any service conduit installed behind the AE meter and all of the Customer's metering and service equipment. (See section 1.2.0 for phone numbers.)
- Where underground work includes conduit for interconnection of a solar system, AE Solar Inspections must also inspect. (See Distributed Generation Interconnection section)

IMPORTANT: Do not backfill trench or encase 90-degree bend(s) or any conduit head of the AE meter until the above inspections by AE have been completed and approved.

2. *AE Responsibility*

- a. AE shall furnish, install, own, and maintain the following in accordance with the AE plans and specifications as provided by AE Design:
 - Transformer
 - Primary riser pole adjacent to Customer's property line and complete riser up the pole
 - Primary conductors from primary riser pole to transformer. There may be a charge for the installation of the primary conductors based on the cost differential between the underground installation cost and an estimated overhead installation cost to serve the same load.
- b. AE shall make the cable terminations at the transformer. The point of service shall be the secondary compartment of the transformer or as designated by AE Design.

1.5.2.7 **Primary Voltage Service (Overhead and Underground) - Commercial**

- A. **General.** AE will provide electric service at a primary voltage of 12,470 Wye/7200V to the point of service upon a Customer's request and subject to the following conditions:
 1. AE Design will determine the primary voltage electric service capacity (kVA) available at the service location (see 1.5.2.2).
 2. For *overhead primary voltage service*, see 1.5.2.7.B. For *underground primary voltage service*, see 1.5.2.7.C.
 3. The Customer shall provide an AE-approved fault-interrupting device (fuses, breaker, or such other device that can also serve as a service disconnect) that will interrupt the maximum fault current available on the AE distribution system at the

POS and will coordinate with other AE fault interrupting equipment as determined by AE Design. The Customer shall provide AE Design with two sets of interrupting device- operating curves and allow 30 days for evaluation prior to purchasing the interrupting equipment. Note: Larger primary metered customers that require any changes to Austin Energy's feeder relays will be responsible for charges related to arc flash mitigation up to, and including, replacement of feeders relays.

4. The Customer shall procure at Customer's own expense all facilities and equipment, including but not limited to primary metering equipment and enclosure (if underground), fault-current interrupting device, transformers, poles, conductors, manholes, and such required to take electric service at primary voltage as required in this Design Criteria and as specified by AE Design and the AE Distribution Metering Operations business unit.
5. *Conversions.* The Customer shall assume and pay all costs incurred by AE to convert the Customer to primary voltage service (plus any system changes if necessary).
6. AE may deny the primary voltage service option to a Customer if AE Design determines that providing primary service will have an adverse impact on AE's electric system or on service to another Customer.
7. THE CUSTOMER ASSUMES ALL RESPONSIBILITY FOR FURNISHING, INSTALLING, OWNING, MAINTAINING AND OPERATING ALL FACILITIES ON THE CUSTOMER'S SIDE OF THE POINT OF SERVICE. All Customer-owned installations shall be in accordance with the NESC and NEC.
8. The point of service shall be at the primary or metering enclosure. The enclosure shall be placed at a location nearest existing AE facilities as accepted and approved by AE Design.
9. In order to provide as continuous a service as possible, it is important for primary voltage Customers to consult with AE Design concerning the engineering, operating, and maintenance aspects of the Customer's facilities and possible problems and hazards associated with primary service. (AE normally does not provide secondary voltage service(s) to a property or Customer that is already primary metered but may provide separate secondary voltage service(s), if available, at a total cost to the Customer.)
10. After consultation with the Customer and his/her engineer and before any construction has begun, the Customer's engineer shall supply a detailed set of plans for the proposed primary system to AE Design for review. Things such as available fault current, both present and future, operating voltage level and proper coordination of Customer's protective equipment with the facilities of AE should be determined before the Customer makes any equipment or facilities selection. In addition, comprehensive mechanical and one-line drawings (two sets) shall be supplied to AE Design for any switchgear that will interface with AE facilities.

THE CUSTOMER SHALL FURNISH, INSTALL, OWN, AND MAINTAIN ALL FACILITIES FOR DISTRIBUTING AND TRANSFORMING PRIMARY VOLTAGE TO ANY OTHER SERVICE VOLTAGE THAT MAY BE REQUIRED BY THE CUSTOMER.

B. Overhead Primary Voltage Service

1. AE will install the overhead primary metering equipment, the meter loop, and the meter on an AE pole and the Customer will pay the total cost for this installation.
2. The primary meter pole will be the point of service (unless otherwise designated by AE Design). AE will connect the Customer's conductors to AE conductors at this pole.
3. The Customer shall furnish and install an AE-approved primary voltage fault interrupting device on the Customer's first pole or other supporting structure on the load side of the point of service in accordance with the City's specifications and requirements. These installations shall be approved by AE Design to ensure compatibility with existing AE equipment.
4. AE shall maintain all facilities up to the point of service.
5. The Customer shall be responsible for maintaining all facilities beyond the point of service.
6. The COA DSD Building Inspection division (and other regulating bodies) will inspect the installation of the Customer's primary service and equipment on the load side of the Customer's point of service including the primary metering enclosure.

C. Underground Primary Voltage Service

1. The Customer shall furnish and install conduit with respect to final grade in accordance with AE Design's specifications from the Customer's primary metering enclosure to the AE pole or a point on the Customer's property line designated by AE Design. Contact AE Design for details.
2. Where required, AE shall furnish and install conduit offsite from the Customer's property line to AE's facilities at the Customer's expense.
3. AE shall furnish and install primary cables from AE's facilities to Customer's primary metering enclosure. The Customer shall furnish and install a primary metering enclosure. The enclosure shall contain:
 - a. The primary fault protection equipment (to separate the Customer's facilities from the AE distribution system in the event of a fault on the Customer's system)
 - b. The switching/disconnect equipment
 - c. The metering transformers (potential transformers and current transformers pre-wired to terminal boards for easy external access) as a part of the primary metering equipment enclosure at the point of service in accordance with AE's specifications and requirements (Contact AE Design).

AE Design and the AE Distribution Metering Operation business unit shall

inspect and approve this installation to ensure compatibility with existing AE equipment.

4. The AE meter shall be mounted on a separate stand installed on an extension of the primary metering enclosure pad or on a separate pad adjacent to (must be visible from and not more than 30 feet from) the primary metering enclosure pad similar to Section 1.18.0 Appendix and Exhibits, Figure 1-11 for secondary metering installed in the secondary compartments of pad-mounted transformers.
5. AE shall maintain all facilities to the point of service.
6. The COA Electrical Inspection division (and other regulating bodies) will inspect the final installation of the Customer's metering enclosure and all the primary service equipment on the load side of the Customer's point of service.
7. The Customer shall be responsible for maintaining all facilities beyond the point of service except AE meters.

1.5.2.8 Service from Open Bushing Transformers in Fenced Enclosures - Commercial

- A. New installations of AE open bushing transformers in fenced enclosures shall not be approved. Existing installations with this style of service shall be changed to pad-mounted transformer service if the Customer's service is enlarged or modified (see 1.5.2.6).
- B. Conversion to pad-mounted transformer service shall also conform to the following conditions:
 1. The Customer shall furnish and install the concrete pad and conduit system in accordance with a design provided by AE Design. This includes:
 - a. Pull-boxes and/or manholes, load bearing or nonbearing, at the base of the pole
 - b. Stub-up from the pull-box and/or manhole to pole
 - c. First 10-foot section of riser conduit (rigid metal) up the pole.
 2. AE shall furnish and install the primary conductor from AE's riser pole to the transformer.
 3. AE shall furnish and install the transformers.
 4. The Customer shall furnish and install the service-entrance conductors to the secondary bushings of the AE transformer(s).

1.5.2.9 Secondary Voltage Service to Multiple-Meter/Shell Commercial Buildings

- A. **Service Disconnects and Meters.** All multiple meter/shell buildings shall have all service disconnects and meters grouped in a common location on the exterior finished surface of the building or structure after and adjacent to the service distribution enclosure. All meters and disconnects shall be permanently sequentially marked, in

order of each respective occupancy or unit. Each meter shall have a service disconnect consisting of one fused switch or circuit breaker. *There shall not be any means of disconnect ahead of the SDE or wireway.*

All new service terminal blocks ahead of the meter(s) shall be located in the service distribution enclosure. The wireway and SDE should be sized according to the table SDE and Wireway Specifications in Section 1.8.5. Commercial transocket or CT services. – the conductors for a CT service may also use the common wireway if the CT service is located on the end of the wireway. Transocket or CT services served from a common wireway shall be limited to one service disconnect.

- B. The electrical service for multiple meter/shell building shall comply with the following requirements unless written approval is obtained from AE Design. (Customers should also contact the COA DSD Building Inspections division or the Development Assistance Center.)
1. A multiple meter/shell building shall be given only one secondary voltage from AE's facilities. All metered occupancies in that building shall be required to design their service to use that one voltage. If an occupant requires another voltage, then it shall be the Customer's responsibility to furnish, install, own, and maintain the equipment necessary to transform AE's voltage to the voltage required.

EXCEPTIONS: 1) A building or structure that has a point of service with 120/240V or 120/208V service voltage (such as, strip shopping center) may be given additional points of service for lease space(s) having an estimated demand of 600 kVA or greater (such as anchor store) as determined by AE Design. 2) Buildings greater than 400 feet in length may qualify for an additional point of service. Contact AE Design.

EXCEPTION: For 277/480V self-contained meter sockets, the service disconnect shall be installed on the line side (ahead) of the metering equipment. [LINE-DISCONNECT-METER-LOAD] (see 1.5.2.4.B.11 and 12).

HIGHLY RECOMMENDED: To allow ample space for future services, the Customer should stack the service disconnect and the meter socket.

2. The Customer shall furnish, install, own, and maintain equipment on the load side (after) of the point of service, including, but not limited to, service equipment, conduits, conductors, service distribution enclosures, junction boxes, wireways, CT enclosures, transockets, meter pedestals, modular metering, and all related apparatus. Each Customer's service installation shall be approved by COA Plan Review and DSD Building Inspections divisions, with maximum consideration to its impact on the future installation of services. No installation shall be approved that materially hinders the addition of future services.
3. For underground installations, the Customer shall install conductors in the rear conduits of the secondary compartment of the AE pad-mount transformer first to allow easy access for future service. Conduits shall be installed from the secondary compartment of the padmount transformer to the service distribution enclosure so that the rear conduits in the transformer are also the rear conduits in the service distribution enclosure. Load side conductors are not permitted to exit the bottom section of the service distribution enclosure. This area shall be reserved for the line

side conductors.

4. The Customer is responsible for all terminations in the service distribution enclosure.
5. The Customer's initial electrical installation shall include the following:
 - a. Service distribution enclosure. Contact the Development Review & Inspection or COA DSD Building Inspections division for information and written approval prior to purchasing and installation.
 - b. The required number and size of service conductors, as per calculated load for entire building per the NEC, must be pulled from the point of service and properly terminated in service distribution enclosure
 - c. Proper service grounding and bonding as indicated in 1.5.2.1.O *Grounding and Bonding of Electric Services*.
 - d. Wireways, metering equipment, service disconnects, terminal blocks, lugs, and any other equipment to complete service installation as required.
 - For underground services, adherence to AE Design requirements (such as transformer pads, primary and secondary conduit, primary and secondary risers, service boxes, and pull-boxes) is mandatory (see 1.5.2.4).
 - For overhead services, one or multiple one-point racks and weatherheads should be installed as required (see 1.5.2.3.A.5). Every weatherhead shall have a neutral conductor(s) and the neutral conductor(s) must have the full current-carrying capacity of the largest energized conductor(s).
6. *House Meter*. The Customer may install one self-contained meter socket for security lighting, fire safety, sprinkler system, and such. The service conductors for this service may be served from either the service distribution enclosure or point of service (the Customer may request and install an optional 2-inch conduit in the pad-mounted transformer secondary compartment for the house meter service). The location of the meter socket and service disconnect shall be within sight of (or visible and not more than 50 feet from) the service distribution enclosure.

Overhead Service: Remember in planning for a house meter that no more than six service conductors per phase shall be connected at the point of service.

Underground Service: The optional 2-inch house meter conduit is in addition to the maximum number of conduits permitted by the AE Design. If there is ample space, it shall be installed at the rear of the secondary compartment of the pad-mount transformer behind the required conduits.

HIGHLY RECOMMENDED: The *house meter* service should be installed so as to allow ample space for future services.

HIGHLY RECOMMENDED: For safety reasons, the Customer should contact AE to have the electric power de-energized before working inside a service distribution enclosure. The Customer is responsible for forewarning other tenants being served from this enclosure and/or transformer when de-energizing will occur.

1.5.2.10 Secondary Voltage Service to Combination Commercial/Residential Buildings

- A. Combination commercial/residential buildings, such as multi-story condominiums or apartments with commercial/retail businesses on the first few floors and residential dwellings on the upper floors, may be served with separate secondary voltage services and treated as separate commercial and multi-metered residential Customers (at the Customer's request) under the following conditions:
 - 1. The commercial and residential portions are grouped such that they are distinctly separate load areas as determined by AE Design
 - 2. Electrically separate systems are separated from each other by a 2-hour fire wall minimum
 - 3. Both services are not accessible from the same space as determined by the COA DSD Building Inspections division and any other authorized inspection entity.
- B. The residential and commercial services will both be subject to the respective conditions and requirements of this Design Criteria. All AE metering must be installed at the first floor or ground level (except as allowed in writing by AE Distribution Metering). If metering is allowed above the first floor/ground level, it must be accessible by AE personnel from the ground level 24/7. The main disconnects for each metering room must be located at the ground floor level. (See Section 1.8.4) For more information, contact AE Design.
- C. Combination commercial/residential buildings that are not grouped into distinctly separate commercial and residential areas (as determined by AE Design) will be treated as all commercial per the requirements of this Design Criteria Manual.
- D. All three-phase service requests and all single-phase requests where the services to both the commercial and residential sections of a combination building (or to separate residential and commercial buildings) must be provided from the same AE transformer will be treated as all commercial as far as Customer requirements are concerned and are subject to the commercial requirements of this Design Criteria and AE Design.

1.5.2.11 Electric Service Inspections – Commercial

- A. AE Work Management shall inspect all commercial (non-network) *underground* civil work installed by the Customer *for AE facilities* and all service lateral conduit ahead of the AE meter except as designated by AE Design. The inspection of any underground civil work must be completed before the Customer backfills the excavation.

HIGHLY RECOMMENDED: Contact the AE Work Management business unit for an on-site preconstruction review with civil work inspector of the proposed civil installation.

Where underground work includes conduit for interconnection of a solar system, AE Solar Inspections must also inspect. (See Distributed Generation Interconnection

section)

- B. COA DSD Building Inspections division must inspect all *underground* Customer-installed, -owned, and -maintained service lateral *conductors* (see Section 1.2.0). Again, AE Work Management shall inspect *all service lateral conduits installed ahead of the AE meter*.
- C. AE Distribution Metering Operations, AE Spots & Conduit, or AE Distribution Design (depending on the nature and stage of the project) shall inspect all Customer electric service installations (new or changes to existing) on the exterior finished surface of a building or structure served by AE up to and including the point of service. Inspections are completed both during construction and upon completion to ensure compliance with the NESC and the AE Design Criteria.
- D. AE cannot install or energize the permanent electric service until the electric service inspection has been made and approved as required in this Design Criteria, and AE has received notice of inspection/written approval from the COA DSD Building Inspections division (and any other authorized City of Austin entity).
- E. Only AE may make the connections (and disconnections) of the Customer's wiring to AE's facilities. In addition, only AE personnel may remove AE meters **or** break City seals except in cases specifically authorized by AE or its designee (call AE Distribution Metering Operations business unit). The following will be inspected by AE, or its designee, prior to or at the time of the connection of metering equipment as indicated:
 - 1. Meter Socket(s) – COA DSD Building Inspections division (EIS)
 - 2. Service Distribution Enclosure – EIS.
 - 3. CT Meter Services – AE Distribution Metering Operations business unit.
 - 4. Old service check (no meter at location) – Start with COA Development Services Department.
 - 5. Turn on the meter (meter existing) – AE at time service is turned on.
 - 6. Read and change meter – AE at the time of reading and change.

1.5.3 RESIDENTIAL Service in Non-Network Areas

(See section 1.3.0 and 1.4.0)

1.5.3.1 General Conditions and Requirements – Residential

- A. **Prior to Electrical Service Installation.** Before starting work on any new or upgraded electric service, the Customer shall ensure the land is a legal lot or tract as required under the City of Austin Land Development Code.
- B. **Contact AE Design or AE Spots & Conduit.** (See Section 1.4.0) In order to facilitate electric service availability when needed, the Customer should discuss all electrical service issues with AE Design or AE Spots & Conduit well in advance of the desired service date to determine the requirements and time frame for providing electric service. Necessary information that should be included in the ESPA includes the exact location of the property to be served, such as street address, lot and block number of the subdivision, service voltage, equipment characteristics, connected load, and the size of the service entrance equipment including equipment ratings.
- C. **Charges.** The Customer may be required to pay AE a line extension charge and/or an

excess facilities/excess costs charge (see Section 1.3.0). AE Design will determine the applicable charges.

- D. **Service Location/Property Address.** Property address must be located so that it will be visible from public right of way before the installation of the temporary meter loop. The address must be clearly marked on the meter loop, meter pole, and/or meter pole braces. The property address must be visible during the design and construction phase and after completion of the project.
- E. **Accessibility.** AE infrastructure facilities will only be placed in locations that are always truck accessible (see Section 1.3.16).
- F. **Grounding and Bonding of Electric Services.** Electric services, including, but not limited to, service equipment, raceways, service distribution enclosures, junction boxes, wireways, enclosures, and any service conductor to be grounded/bonded must be grounded/bonded in accordance with the NEC.

EXCEPTION: The grounding/bonding conductors for all services shall be copper only, with a minimum size of #6 AWG.

- G. **Meter Loop Location.** Residential meter loops must not be installed on manufactured homes, mobile homes, portable buildings, or similar structures that are not legally a part of the property. (Exceptions are approved service poles, structures, pedestals, and such.)

The Spot & Conduit business unit and/or AE Design shall designate and approve meter and service equipment locations (see Sections 1.5.3.6 & 1.5.3.7 for multiple metered buildings). The meter location(s) should normally be on the first floor or ground level. AE Design must approve meter location exceptions in writing.

- H. **Electric Permit Requirements for Meter Loop Placement/Meter Loop Replacement.** An electric permit will be required for any new meter loop or for any meter loop replacement. Any replacement meter loop must be installed according to current codes whenever there is a need to replace a meter loop or a meter loop pole (such as replace a rotten service pole).

COMMENT: When residential services are being rebuilt for upgrade or repair, the Customer should contact COA DSD Building Inspections division for written approval of service entrance equipment and method of installation.

- I. Three-phase is not a standard AE residential service voltage. For Customers requesting three-phase secondary voltage service for residential dwellings, AE Design must approve such requests and determine if there will be an excess facilities cost. The Customer must take service under the conditions and requirements of commercial service (see Section 1.5.2.11). The point of service for three-phase service shall be the secondary compartment of the transformer or as designated by AE Design.

1.5.3.2 Available Residential Electric Service

Electric residential service available in the AE service area (excluding network) is as follows in Table 1.5.3.2.

Table 1.5.3.2						
VOLTAGE [2] [3] [5]	RESIDENTIAL [4]					
	Overhead		Secondary Riser		Underground	
	min	max	min	Max	min	Max
120/240V, 1PH, 3-Wire	[1]	800	[1]	800	[1]	800

- [1] Contact AE Design concerning the AE Line Extension Policy
- [2] Standard residential service voltage is 120/240V single-phase. Contact AE Design if you have any questions or other residential service requirements.
- [3] If the available service does not meet the Customer's requirements as requested in the ESPA, AE may agree to supply the type of electric service Customer requires at an additional cost to the Customer if 1) the request is feasible and if 2) the Customer's equipment and/or the manner of use does not jeopardize the quality of service to other AE Customers as determined by AE Design.
- [4] 750 kcmil is the maximum wire size allowed.
- [5] For the purpose of sizing AE facilities, AE Design shall determine the maximum expected Customer demand load amps that will be seen by AE facilities from the Customer's total connected undiversified load information and building size as documented on the ESPA form. AE facilities will be sized by AE Design accordingly. The maximum demand load amp services available from AE are defined in Table 1.5.2.2.

1.5.3.3 Overhead Residential Installations

- A. **Standard AE residential electric service** is single-phase overhead on wood poles. AE installs, owns, and maintains the overhead facilities (primary, secondary, and service drops) from AE facilities to the point of service.
- B. **A permanent overhead service drop not installed on the building or structure** shall meet the following requirements:
 1. Be installed on a rack.
 2. Consist of non-corrosive metal.
 3. Be supported by galvanized rigid steel 4-inch minimum diameter or a 6" x 6" pressure treated pole/post.

The poles/posts shall be installed a minimum of 3 feet deep encased in concrete. Rack shall be installed permanently with sufficient bracing and shall be stationary.

For Customer services requiring meter bases rated over 350 amps, the pole or rack will need to be engineered and a drawing provided confirming that the structure will support the AE overhead service tension. AE Design will provide the pole/structure loading requirements for the overhead service.

C. Service-Drop Conductors - Residential

1. *General.* Overhead service-drop conductors that are furnished and installed by AE connect AE's supply lines to the Customer-provided service conductors. The point of service is the point at which AE's and the Customer's conductors are connected at the weatherhead(s) and one-point rack(s) location or as designated by AE Design. All connections of AE conductors at the point of service shall be made by AE. For multiple weatherhead installations, every weatherhead shall have a neutral conductor and the neutral conductor must have the full current-carrying capacity of the largest energized conductor.

2. *Clearances/Attachment Heights.* NESC (Section 23) along with AE Design requirements require minimum clearances for service-drop conductors from final grade or other accessible surfaces. These minimum required clearances shall be maintained at all times. To facilitate these clearances, minimum attachment heights shall be as listed in Table 1.5.3.3.C.2. For more information, contact AE Design.

TABLE 1.5.3.3.C.2 CLEARANCES AND ATTACHMENT HEIGHTS FOR SERVICE-DROP CONDUCTORS RESIDENTIAL SERVICES			
	<i>Minimum Clearance From Final Grade/ Other Accessible Surface (Feet)</i>	<i>Attachment Height^{1,2}</i>	
		<i>Minimum (Feet)</i>	<i>Maximum (Feet)</i>
Residential services over areas accessible to pedestrians only.	12	12.5	15
Services passing over driveways, or parking lots and alleys (not subject to truck traffic).	16	16	18
Services passing over roads, streets, alleys, parking lots, subject to truck traffic or other land such as cultivated, grazing, forest, orchards, etc. traversed by vehicles.	18	18	21
A minimum clearance above the roof of 18 inches to mast shall be permitted for service mast installations, including, but not limited to service-mast (through-the-roof) installations where the voltage between conductors does not exceed 300V.			
Where the voltage between conductors does not exceed 300V and the mast is located within 4 feet of the edge of the roof and above only the overhanging portion of the roof, a minimum clearance of 18 inches shall be permitted for service-mast (through-the-roof) installation. No more than 10 feet of service-drop conductors may pass above the roof overhang.			
No more than 6 feet of service-drop conductors may pass over the roof to the structure it serves.			

1. The Spot & Conduit business unit (for single-phase services) or AE Design business unit (for three-phase services) may approve an attachment height, other than those listed in this table, based on the circumstances at the site location. However, minimum attachment height shall be maintained at all times to meet NESC requirements.
2. Attachment heights should in no case exceed the maximum as listed unless approved in advance by AE Spot & Conduit business unit (for single-phase services) or AE Design (for three-phase services).
3. All clearances shall comply with rules and exceptions as stated in the NESC in addition to the following:
 - a. Where physical features, such as terrain or vegetation are unusual, additional attachment height may be required to allow for conductor sag.
 - b. Service Mast (Supporting/Through Roof): Service mast must be a minimum 2-inch Intermediate Metal Conduit. Service mast through the roof and over 4 feet from strapping or supports must be guyed within 3 inches of the point of attachment. The one-point rack may be attached to service mast, provided the service mast is supporting and through the roof. When a one-point rack (clamp-on type) is attached to service mast, no fittings, such as couplings, may be located between the roof and point of attachment.
 - c. Service Mast (Non-supporting/Not-Through-Roof): Service mast must be Rigid Metal, Intermediate Metal, or EMT conduit. The one-point rack may **not** be attached to a non-supporting/not-through-roof service mast.
 - d. A maximum of 6 feet of service-drop conductors may pass over the roof of the structure being served, regardless of required height above the roof and/or slope of the roof. (Location must be accessible to AE personnel.)
 - e. Service-drop conductors shall not pass within 5 feet, measured horizontally, or over or under any portion of a building or structure to provide service to another building or structure. Additional clearances may be required as indicated in Section 23 of the NESC.

EXCEPTION: A maximum of 10 feet of service-drop conductors may pass over the roof of the building or structure to which the service-drop is not attached and/or slope of the roof when the service drop meets all the following conditions:

- The building or structure is on the same piece of property and owned by the same Customer as the building being served to which the service-drop is attached (such as a garage or storage building)
 - The voltage between the service-drop conductors does not exceed 300 volts
 - The minimum vertical clearance is a minimum of 3.5 feet,
- f. Service-drop conductors must not pass within 7.5 feet, measured horizontally, or over or under signs, chimneys, billboards, radio and television antennas, tanks, and other installations not classified as buildings. Additional clearances

may be required as indicated in Section 23 of the NESC.

HIGHLY RECOMMENDED: For safety reasons, the Customer should contact AE to de-energize the electric power before working near AE facilities.

4. *Anchorage of Overhead Service-Drop Conductors*

- a. The Customer must provide (1) an adequate anchorage for the service-drop conductors using a one-point rack for residential services or multiple one-point racks for large residential services and (2) a suitable location for AE's metering equipment. Customer shall furnish install, own and maintain the one-point rack(s).
- b. For services rated 800 amps or less, a single one-point rack shall be used for 3-wire and 4-wire. The rack shall be installed within 12 inches below the weatherhead at the required attachment height.

For services rated over 800 amps, three one-point racks must be installed for 3-wire services and four one-point racks for 4-wire services. The racks shall be installed 10 to 12 inches apart, measured center to center.

Factory-assembled racks are allowed, as approved by AE Design. The Customer shall furnish, install, own, and maintain these racks.

Multiple racks installed *horizontally* must be installed a maximum of 12 inches below the weatherhead(s) at the required attachment height. The center point of the racks must be directly below the weatherhead(s).

Multiple racks installed *vertically* shall be installed with the highest rack within 12 inches below the weatherhead and the lowest rack at the required attachment height.

- c. The service-drop conductors must be attached to a permanent building or structure nearest AE's last designated facilities (pole). The Spot & Conduit business unit or AE Design shall determine the point of attachment on the Customer's building or structure.

At AE's option and discretion, the attachment may be made at some other point, either because of the location and type of AE's distribution system or in order to conform with the construction of the building. This point of attachment must be agreed upon by the Customer and the Spot & Conduit business unit or AE Design (see Section 1.4.0) before the installation of the service conductors, service equipment, one-point rack(s), metering equipment, or any other wiring on the premises.

Customer must furnish, install, own and maintain the one-point rack(s) at this point of attachment.

- d. In order to provide adequate support for the service, the Customer must make provisions for the dead-end attachment (one-point rack) to be securely attached to the structural frame of the building using a minimum ½-inch diameter threaded bolt with nut and washers. On a wood frame structure,

the Customer shall provide a securely attached minimum size 2-inch x 4-inch header for this purpose. Meter sockets and service entrance to the point of service are not considered complete until the one-point rack(s) has been properly installed.

- e. Wherever the building height does not permit the required clearances for the service-drop conductors, the Customer must provide approved permanent metal service supports (see 1.5.3.3.B).

D. **Service Drop Lengths.** The Customer's permanent/temporary service entrance facilities must be installed according to the following requirements relative to the service drop length (see also Section 1.10.6.1):

10-foot minimum	Regardless of service size: Service drop attachment must be located out from under AE facilities measured horizontally from and perpendicular to AE's facilities (poles and overhead lines) (Also see Section 1.10.6.1.) AE will determine total permissible service drop length.
75-foot maximum	For service entrance equipment rated 225 amps or less: Service drop length measured horizontally/radially, from AE's facilities (pole serving Customer's facilities)
55-foot maximum	For service entrance equipment rated over 225 amps but 350 amps or less: Service drop length measured horizontally/radially from AE's facilities (pole service Customer's facilities)
Contact AE Design	For service entrance equipment rated more than 350 amps.

All other maximum service lengths for larger loads or other smaller load conditions that allow longer service drop lengths than shown above shall be specified by AE Design. Point of attachment must be able to withstand 400 pounds of conductor tension.

E. **Service Head (Weatherhead)**

- 1. *Customer's Service Conductors.* To permit connection with AE's service-drop conductors, the Customer's service conductors must extend as follows according to the wire size:

#6 AWG through #1/0 AWG	18-inch minimum plus the distance from the service head to the rack
#2/0 AWG and larger	36-inch minimum plus the distance from the service head to the rack

If these conductor lengths are not provided, the Customer must rewire to meet the requirement. All Customer service conductors shall have correct phase identification markings 12 inches from the service weatherhead.

- 2. The weatherhead head shall be approved weatherproof construction and installed to prevent the entrance of rain. The service head shall terminate above and within

12 inches of the one-point rack on the building, where the structure will permit.

3. For multiple weatherheads, customer service conductors shall reach the rack(s) on the building (plus 36 inches). AE SHALL CONNECT THE CUSTOMER'S CONDUCTORS WITH AE'S SERVICE-DROP CONDUCTORS. No more than six service conductors per phase will be connected at the point of service.
 4. For multiple weatherhead installations, every weatherhead shall have a neutral conductor. The neutral conductor must have the full current-carrying capacity of the largest energized conductor.
- F. **Tree Trimming.** The Customer is responsible for all tree-trimming activities on the Customer's property required by AE to allow for the safe installation of new (or for Customer-requested modifications to) electrical facilities by AE. The customer shall not trim trees adjacent to AE energized facilities. If such trimming is required or deemed necessary, contact Tree Trimming (512) 322-6771.
- G. **Clearances.** See Sections 1.5.3.3.C.2 and 1.10.0.

1.5.3.4 Underground Residential Electric Service Installations

A. Underground Service Conditions and Requirements

1. AE normally requires the Customer to install with respect to final grade all the civil work (see item 5 below) for underground AE facilities located on the Customer's property as designated by AE Design (see Section 1.4.0).
2. *Underground Service Lateral from Existing AE Underground Facilities. See Service Only in Section 1.4.2.3.*
3. *Underground Agreement for Electric Service (Letter of Agreement).* The conditions and costs for underground electric service, or infrastructure, supplied to a Customer shall be covered by an *Agreement for Electric Service* letter provided by AE Design.

IMPORTANT: This agreement by AE to the serve a particular installation underground applies only to the specified wiring and equipment (or the particular AE electrical distribution infrastructure needed) at the Customer-specified location given on the ESPA. The Customer must notify AE Design as soon as possible concerning any contemplated change so that proper provisions may be made for adequate service, connection, and metering facilities.

4. *AE-installed underground residential service lateral conductors* shall be installed a maximum of 150 feet from the Customer's service equipment to AE's nearest designated service box, pull-box, or transformer. All services exceeding 200 feet shall be referred to AE Design for voltage drop and flicker calculations and determining the cost to the Customer.

5. Customer-installed Civil Work

- a. Customer-installed underground primary, secondary, and service conduit on the Customer's property for AE facilities and all conduit installed on the line side (ahead) of the AE metering equipment shall be installed with respect to final grade and shall not be installed under or through a building or structure (including, but not limited to, porches, stairways, decks, carports, garages, and storage buildings).
- b. All primary, secondary, and service conduit in which AE installs the conductors and all service conduit ahead of the AE meter shall be limited to a maximum of two 90-degree bends, or equivalent, between accessible pulling points (such as transformer, service box, pull-box, or meter socket). AE Design shall determine installation requirements of primary and secondary risers and underground conduit.
- c. Service conduit, from the point of service or the last AE facility to the last 90-degree bend ahead of the metering equipment shall be intermediate metal or schedule 80 PVC. The last 90-degree bend with 24-inch minimum bend radius and the service riser shall be rigid metal or schedule 80 PVC where conduit is installed in backfill, and minimum schedule 40 PVC when encased in concrete. No heated bends are permitted. There shall be no additional bends between the service riser and the AE metering equipment.
- d. Secondary/service conduit runs of more than 75 feet shall also include an AE approved pull-string.

CAUTION: The Customer is not allowed under any circumstances to enter any AE equipment, manhole, pull-box, or other such facilities containing AE primary voltage cable. (Contact AE Design or AE Spots and Conduit)

- e. Primary cable conduit must be installed a minimum of 30 inches deep and secondary and service conduit must be installed a minimum of 24 inches deep measured to the top of the conduit with for the current grade and not less than 30 and 24 inches respectively for the final grade

Only communication cables are allowed in the same trench with electric conduits and shall be installed a minimum of 6 inches from the top electrical conduit (See Section 1.10.5.A). Communication conduits are not allowed over AE main line duct banks (see main line definition in glossary.). For more information, contact AE Design.

- f. The Customer-installed civil work (conduit, pads, and such) required for permanent underground service (or infrastructure) shall meet the requirements as specified in this Design Criteria and as required by AE Design by drawing and/or in the Agreement for Electric Service. The service installation shall be completed from the last or closest AE facility and/or point of service, as determined by AE, up to and including the service equipment. Civil work installation shall meet the requirements of AE Design and this Design Criteria. For more information, contact AE Design.
- g. After the civil work for AE facilities has been installed, inspected, and approved by AE, the final grade shall not be changed by any excavation, filling, landscaping, or sodding without the prior written approval of Austin Energy

(see Section 1.10.10).

- h. *AE Responsibility for Customer-installed Facilities.* AE ASSUMES NO RESPONSIBILITY FOR ANY PORTION OF THE CUSTOMER'S INSTALLATION. AE reserves the right to discontinue or refuse service to any apparatus or device which is not properly constructed, controlled, and protected, or for which the Customer has not provided the necessary easements or obtained the required inspections and permits, or for which (in AE's opinion) may adversely affect the services to any Customer or that may be an improper or unsafe type.

B. Underground Residential Service from a Secondary Riser

1. *General.* In areas where overhead primary distribution facilities are available, the secondary riser is the preferred method of providing underground 120/240V single-phase service for 800 amps or less of maximum demand ampacity as determined by AE Design and that meet conditions outlined in Table 1.5.3.2. Underground pad-mount transformer services in overhead areas for such loads will be provided at the discretion of AE Design or if the Customer pays for the additional cost of such a service.
2. *Customer Installation Responsibilities*
 - a. The Customer shall furnish and install a service box (load bearing or nonbearing) at the base of the pole as specified by AE Design. An additional secondary pullbox past the pullbox at the base of the pole (maximum of 2 pullboxes) will be allowed where the maximum distance between pullboxes is 150 feet, the pullbox nearest to the customers' property is the point of service, and the customer is responsible for pulling the wire from the point of service (nearest pullbox) to the meter.
 - b. The Customer shall furnish and install the stub-up from service box/pull-box to the pole and a first 10-foot section of riser conduit (rigid metal) up pole. Riser's 90-degree bend with minimum 24-inch bend set by Customer shall be a rigid metal conduit and encased in concrete. The number and size of riser conduits will be determined by AE Design.
 - c. The Customer shall dig and backfill trench from meter/service location to service box/pull-box. Trench (on the Customer's property) shall be a minimum of 24 inches deep from grade to the top of service conduit.
 - d. The Customer shall furnish, install, and maintain the service conduit (approved rigid metal or schedule 80 PVC) from the last 90-degree bend ahead of the meter/service location to service box/pull-box. The last 90-degree bend with 24-inch minimum bend radius and the service riser shall be approved rigid metal or schedule 80 PVC where conduit is installed in backfill, and minimum schedule 40 PVC when encased in concrete. Service conduit shall be 2, 3, 4, or 5 inches with no half sizes permitted.
 - e. The Customer shall furnish, install, own, and maintain the service conductors from meter/service location into service box/pull-box. The point of service shall be the service box/pull-box or as designated by AE Design. The Customer shall leave a 36-inch minimum conductor tail extending from the top of the service box or pull-box. If a bonding conductor is required by the

NEC, the Customer shall install the bonding conductor, and AE shall make the necessary connections.

- f. Service/pull box size based on secondary conductor size and number of conductors installed and planned for future installations.
- g. The Customer shall request the following inspections:
 - **AE Work Management** - inspects the service lateral conduit from the service box/pull-box to the meter, meter pedestal, or service equipment location, the service-box/pull-box, and the conduit from the service-box/pull-box to the secondary riser, including the 90-degree bend and the 10-foot riser conduit up the pole. AE installs conductors from the service-box/pull-box up the pole.

Contact the AE Work Management business unit (or AE Civil Inspection business unit for Major Project or Network Installations) for an on-site preconstruction review with AE inspector(s) of the proposed Customer-installed civil work installation.

- **COA DSD Building Inspections Division** - inspects the Customer's service conductors from the service box/pull-box to the meter and service equipment location. Customer installs conductors from the service-box/pull-box to the meter.

Do not backfill trench or encase 90-degree bend(s) or conduit in concrete until the above inspections have been completed and approved.

- 3. *AE Installation Responsibility*
 - a. Install riser conduit on pole to complete riser.
 - b. Install conductors in riser conduit from pole-mounted transformer(s) into service-box/pull-box.
 - c. Connect AE conductors with Customer service conductors at the point of service.

C. **Underground Service from Pad-Mounted Transformers to Residential Lots and Subdivisions**

- 1. **General.** Where the underground AE electric *infrastructure* is made available to individual residential lots by means of a system of underground primary voltage cable, secondary voltage cable, pad-mounted transformers, and associated equipment, the Customer (Developer/Builder) must provide space on his or her property for the required AE facilities and equipment.

The Customer must install the civil work for AE facilities installed on the Customer's property and pay AE any additional cost differential between the overhead and underground distribution costs. AE Design will determine this cost.

The Customer must also grant the City an easement on the City's standard form for such installations and any associated underground cable. The padmount transformers and their accessory equipment must be installed on concrete pads.

All Customer-installed civil work for AE facilities must comply with all provisions of

the City of Austin Design Criteria, NESC, NEC, AE Design requirements, and any applicable AE specifications, rules, standards, regulations, and conditions. For more information, contact AE Design.

2. AE will provide single-phase, 120/240V service to residential units with a total combined ampere rating of service disconnects that shall not exceed 350 amps for a single, self-contained meter or 800 amps for a service consisting of two to four meters or CT service. For larger single-phase services, Customer should contact AE Design for availability. (See Table 1.5.3.2 for available service.)
3. In subdivisions completed (utilities installed and available at property line for construction of dwelling units) prior to July 31, 1997, the Customer (generally) must meet the requirements of the July 1, 1997 Developer/Builder Policy for Subdivisions (see 1.5.3.4.C.5 or 6).
4. In subdivisions completed (utilities installed and available at property line for construction of dwelling units) after July 31, 1997, the Customer (generally) must meet the requirements of the July 1, 1997 Developer/Builder Policy for Subdivisions (see 1.5.3.4.C.5 or 6).
5. *Developer/Builder Policy for Subdivisions.* As of July 31, 1997, unless otherwise agreed by AE in its sole discretion, underground service in new residential areas is available according to the following policy:
 - a. Developer/Builder is responsible for all civil work required to extend electrical facilities according to AE's design and construction requirements as required in the *Agreement for Electric Service*, this Design Criteria, the NEC, NESC, and all applicable codes, rules, regulations, standards, specifications, and such.
 - b. Developer/Builder must acquire and provide all of the required materials including, but not limited to the conduit, bell ends, service boxes/ pull-boxes, manholes, manhole covers, or junction boxes. Materials used must meet AE's detailed specifications. No heated bends are permitted.
 - c. Developer/Builder is responsible for conducting all trenching and backfilling activities, including, but not limited to, those required to install the primary and secondary duct systems, installation of service boxes/pull-boxes, conduit, bell ends and for building the concrete transformer pads and meter pedestal foundations according to the AE Design Criteria and AE Design requirements.
 - d. AE reserves the right to inspect the quality of materials as well as the construction phase of a project during the installation of any materials and equipment by the Developer/Builder.
 - e. The Developer/Builder and/or Property Owner shall furnish, install, own and maintain electrical facilities beyond the point of service. AE will furnish, install, own, and maintain the meter.
 - f. AE shall furnish, install, own, and maintain conductors and equipment needed to provide electrical service to residential facilities located on AE's side of the

point of service with the exception of the Customer-installed civil work, which shall be furnished and installed by the Customer.

- g. *AE-installed underground residential service laterals* shall be installed to the closest point of attachment on the residence (or as designated by AE Spots and Conduit). The maximum standard service length is 150 feet from the Customer's service equipment to AE's nearest designated service box, pull-box, or transformer. All service lengths exceeding 150 feet and/or where additional facilities, materials, and/or labor are required may necessitate additional costs and civil work requirements to the Customer.

Secondary/service conduit runs of more than 75 feet shall also include a pull-string approved by AE.

- h. At the house, the Customer shall complete and have inspected the installation of the service lateral riser conduit and 90-degree bend (either intermediate metal or schedule 80 PVC), the metering equipment, and the service disconnect (located on the exterior finished surface of the building or structure) before requesting the service lateral installation by AE.

- 6. *Developer/Builder Optional Policy for Residential Lots & Subdivisions using Meter Pedestals.* Effective June 1, 2005, unless otherwise agreed by AE in its sole discretion, underground service in new residential areas is available for up to 200 ampere maximum underground residential services using meter pedestals according to the following optional policy:

For Customer-provided Meter Pedestals: The point of service will be a meter pedestal provided and installed by the Customer on each individual residential lot (or for multiple lots) as specified in this Design Criteria or designated by AE Design. The Customer shall furnish, install, own, and maintain the meter pedestal(s) and pedestal pad(s) as specified and approved by AE Design, the AE Distribution Metering Operation business unit, and the COA DSD Building Inspections division. The meter pedestal must be located on the Customer's property and no more than 5 feet from the property line closest to the AE facilities as designated by AE Design.

(The Customer must obtain an electric permit from the COA Service Center and obtain an inspection from the COA DSD Building Inspections division for the customer-owned and -installed pedestal and underground service and if located outside of the COA, inspections from any other authorized inspection entity.)

- a. Developer/Builder is responsible for all civil work required to extend primary and secondary electrical facilities according to AE's design and construction requirements as required in the *Agreement for Electric Service*, this Design Criteria, the NEC, NESC, and all applicable codes, rules, regulations, standards, specifications, and such.
- b. Developer/Builder is responsible for acquiring and providing all of the required materials including, but not limited to the conduit, bell ends, meter pedestals, service-boxes/pull-boxes, manholes, manhole covers, or junction boxes. Materials used must meet AE's detailed specifications.

- c. Developer/Builder is responsible for building all concrete transformer and pedestal pads and conducting all trenching and backfilling activities, including, but not limited to, those required to install the primary and secondary conduit/duct systems, meter pedestals/pull-boxes, and conduit bell ends according to this Design Criteria and AE Design requirements.
- d. AE reserves the right to inspect the quality of materials as well as the installation of any materials and equipment by the Developer/Builder at any point during the construction phase of the project.
- e. The Developer/Builder and/or Property Owner shall furnish, install, own, and maintain electrical facilities beyond the point of service (which will include the Customer-provided, owned, and maintained meter pedestal and service lateral). AE will furnish, install, own, and maintain the meter.
- f. Conductors and equipment needed to provide electrical service to residential facilities located on AE's side of the point of service (the meter pedestal) shall be furnished, installed, owned, and maintained by AE, with the exception of the Customer-installed electrical infrastructure civil work, which shall be furnished and installed by the Customer.
- g. AE may provide service to residential subdivisions under the conditions of the July 1, 1997 Developer/Builder policy for Residential Subdivisions if the developer/builder agrees to the conditions of the 1997 policy and pays AE the total cost difference as determined by AE Design and specified in the Agreement for Electric Service letter.

1.5.3.5 Service to Mobile Home, Modular Home, and Manufactured Home Parks

- A. The Customer shall furnish and install the necessary civil work (conduit, transformer pads, service boxes, pull-boxes, and other such structures) required for AE underground facilities and comply with the requirements and conditions of 1.5.3.4.C.6 to satisfy AE infrastructure and special Customer requirements as determined by AE Design.
- B. The Customer shall furnish, install, own, and maintain the meter pedestal and pedestal pad as specified in the Design Criteria or approved by AE Design and the AE Distribution Metering Operation business unit. The Customer shall install all service conduits and the meter pedestal pads as specified by AE Design.
- C. AE shall furnish, install, own, and maintain the necessary primary cable, transformers, and secondary conductors from the service box, pull-box, or transformer to the point of service. The point of service shall be the line side (top) of the self-contained meter socket, the appropriate termination point of a pre-wired meter pedestal, or as designated by AE Design.

1.5.3.6 Service to Multiple-Metered Residential Buildings (Overhead and Underground)

- A. All multiple-metered residential buildings (see 1.5.3.7) shall have all meters grouped in a common location on the exterior finished surface of the building or structure. Should the Customer request the installation of grouped meters with-in the building, Customer shall comply with the requirements of Section 1.9.3.1 G. Each meter service disconnect (or meter base) shall be permanently marked with the address of each respective occupancy or unit. Each dwelling or leased space shall be individually metered. In addition, the electrical service for a multiple-meter residential building shall comply with the following requirements unless written approval is obtained from AE Design.
- B. The Customer shall furnish, install, own, and maintain equipment on the load side of (after) the point of service, including, but not limited to, service equipment, conduits, conductors, service distribution enclosures, junction boxes, wireways, multiple-meter socket assemblies, meter pedestals, and such

For multiple weatherhead overhead installations, each weatherhead shall have a neutral conductor. The neutral conductor must have the full current-carrying capacity of the largest energized conductor.

- C. **Underground.** The Customer shall install the required number and size of service lateral conduits from the AE transformer or pull-box to the service distribution enclosure as determined by AE Design. All spare conduits shall be brought to the building and stubbed up for future use.

When the service distribution enclosure is the point of service (such as single-phase underground service to apartments), AE will install and terminate the AE underground service lateral conductors. Generally, the Customer is responsible for all Customer wiring terminations in the service distribution enclosure.

When the AE transformer or pull-box service is the point of service (such as three-phase underground service to apartments), the Customer will install, terminate, own, and maintain the underground service lateral conductors. The Customer is responsible for all Customer wiring on the load side of the point of service.

HIGHLY RECOMMENDED: For safety reasons, the Customer should contact AE to have the electric power de-energized before working inside any AE-pad-mounted transformer secondary compartment, pull-box, or service distribution enclosure. The Customer is responsible for forewarning other tenants being served from this enclosure and/or transformer when de-energizing will occur.

- D. The Customer shall install wireways, metering equipment, service distribution enclosures, terminal blocks, lugs, and any other equipment to complete service installation as required.
 - 1. *Underground.* Adherence to AE Design requirements (such as transformer pads, primary and secondary conduit, primary and secondary risers, service boxes, and pull-boxes) is mandatory.
 - 2. *Overhead.* One or multiple one-point racks and weatherheads as required.

- E. **House Meter.** The Customer may install one self-contained meter socket per building for security lighting, fire safety, sprinkler system, and such. The service conductors for this service may be served from either the service distribution enclosure, pull-box, or transformer (optional 2-inch conduit). The location of the house meter socket shall be within sight (visible and not more than 50 feet) from the service distribution enclosure.
- F. **Customer-installed Civil Work.** See Sections 1.5.3.4.A.5 and 1.5.3.8.

1.5.3.7 Service to Apartments, townhouses, and condominiums

- A. These types of residential dwelling projects require that the individual residential dwellings each be individually metered (see Section 1.5.3.6). The Customer shall furnish, and install the necessary conduit, transformer pads, service boxes, and pull-boxes as determined by AE Design. AE shall furnish, install, own, and maintain the necessary primary cable and transformers.
- B. For secondary voltage single-phase service, the service lateral conductors shall be installed by AE to the designated point of service (maximum 75 feet). The point of service for single-phase service shall be the service distribution enclosure, or as designated by AE Design. Secondary/service conduit runs of more than 75 feet shall also include an AE approved pull-string.
- C. When the Customer is required to (or chooses to) install, own, and maintain the service conduit and the service lateral conductors, the service conduit installed ahead of the AE meter(s) must not be installed under or through a building or structure, including, but not limited to porches, stairways, decks, carports, garages. Should future ordinances or legislation require the AE meter to be the point of service, the Customer assumes total responsibility for establishing a master-meter/submeter system or relocating the service conduit and service lateral conductors to where they are AE-accessible.
- D. Multi-Meter Banks and Modular Meter Banks (Underground):
 - 1. *The customer shall install the secondary wires from the transformer to the main disconnects and terminate the source side of the disconnects.*
 - 2. *The main disconnects shall be inspected by the COA DSD Building Inspections division.*
 - 3. *Austin Energy shall terminate all secondary wires in the transformer and energize disconnects.*
 - 4. *Austin Energy shall energize complete meter banks as requested.*
 - a. *For meter banks located in the Network Area, all the secondary meter banks must be energized simultaneously when the secondary is being energized.*
- E. For combination commercial/residential buildings, see Section 1.5.2.10.

1.5.3.8 Electric Service Inspections - Residential

- A. All Customer-installed underground civil work for AE facilities and all service lateral conduits installed ahead of the AE meter (see Section 1.5.3.4.A.5) shall be inspected by AE civil inspection personnel (Spot & Conduit for Section 1.4.2.3 services or AE work management for Section 1.4.2.4 services. For exceptions, see 1.5.3.4.B.) The inspection of any Customer-installed underground civil work must be completed before the Customer encases the conduit or 90-degree bends or backfills the excavation.
- B. AE shall inspect all electric service installations or changes on the exterior finished surface of a building or structure served by AE, or its designee, up to and including the point of service both during construction and upon completion to ensure compliance with the NESC and this Austin Energy Design Criteria.
- C. AE cannot render electric service until the electric service inspection has been made and approved, and if required, AE has received notice of written approval from COA DSD Building Inspections division (and other authorized entity) for the remainder of the Customer's electrical installation on the exterior and interior of the building or structure.
- D. Only AE can make the permanent connections of the Customer's wiring to that of AE's facilities unless registered in CDP. AE shall perform all disconnects of service, all meter removals, and all breaking of AE seals, except in cases specifically authorized by AE, or its designee. AE, or its designee, will inspect the following prior to connection of metering equipment:
 - 1. Meter Socket(s) – COA DSD Building Inspections division (EIS)
 - 2. Service Distribution Enclosure – EIS.
 - 3. CT Meter Services – AE Distribution Metering Operations business unit.
 - 4. Old service check (no meter at location) – Start with COA Development Services Department.
 - 5. Turn on the meter (meter existing) – AE at time service is turned on.
 - 6. Read and change meter – AE at the time of reading and change.
- E. Where underground work includes conduit for interconnection of a solar system, AE Solar Inspections must also inspect. (See Distributed Generation Interconnection section)

1.6.0 STREET LIGHTING

Section 1.6.0 provides specific requirements and information for streetlight and outdoor lighting service in the AE service area and for those areas within COA but not within the AE service area.

1.6.1 General Information

The following information is intended to describe and distinguish the standard street lighting and outdoor lighting programs offered by AE. Contact the AE Design business unit for specific details, requirements, and costs.

1.6.2 Streetlights in Existing Residential Areas within Austin's City Limits

Within the city limits of Austin, AE installs streetlights upon request by residential owners. When the affected property owners, which includes the nearest four neighbors, approve the streetlight location(s) and grant the necessary easements (if any) at no cost to AE, AE will proceed with installation of the streetlight(s). The streetlight(s) must meet recommended light levels and spacing as described in the Austin Energy technical specifications and in accordance with the Illuminating Engineering Society of North America (IESNA) standards.

In addition, streetlights will be installed upon request by Police, Fire, EMS, or Public Works departments of COA, or as deemed necessary to address public safety concerns. These installations typically occur at street intersections and curves.

COA will be responsible for the installation, maintenance, and energy charge associated with streetlights installed in the city limits within AE's service area.

1.6.3 Streetlights in Newly Annexed Residential Areas

In newly annexed areas of COA, AE will install streetlights upon request of individual property owners or neighborhood associations. Neighborhood associations shall provide AE with the boundaries of the neighborhood and the names and addresses of the property owners requesting streetlights. AE personnel will provide a streetlight installation plan that shows the location of the streetlights pursuant to the lighting and spacing standards as described in the AE technical specifications and in accordance with the Illuminating Engineering Society of North American (IENA) standards. When the affected property owners approve the streetlight location(s) and grant the necessary easements (if any), AE will proceed with installation of the streetlight(s).

New subdivisions in newly annexed residential areas (or areas scheduled for annexation) will pay the standard AE fee per lot as an aid to construction. The fees will be reviewed on an annual basis and are subject to change. (See Fee Schedule in Section 1.17.0 Glossary for the location of the current fee schedule.)

In newly annexed areas, AE will install streetlights upon request by Police, Fire, EMS, or Public Works departments of COA, or as deemed necessary to address public safety concerns. These installations typically occur at intersections and dangerous curves.

COA will be responsible for the installation, maintenance, and energy charge associated with street lighting installed in the city limits within AE's service area. If the annexed residential area is in another electric utility's service territory, as authorized by the Public Utility Commission of Texas, AE will coordinate installation, maintenance and energy charges with the electric service provider for that area.

1.6.4 Streetlights in New Residential Subdivisions IN Austin’s City Limits Inside and Outside Austin Energy’s Service Area

If the new residential area is in another electric utility’s service territory, as authorized by the Public Utility Commission of Texas, AE will coordinate installation, maintenance and energy charges with the electric service provider for that area.

AE will develop a complete lighting installation plan for new subdivisions with installation pursuant to design. The developer shall be responsible for the installation of the conduit, AE-approved pull string, pull-boxes, and AE standard streetlight foundations. AE will install the standard poles and fixtures. If the developer prefers streetlight poles other than what is normally installed, the developer and AE will collaborate on the type of pole. The developer is responsible for the difference in cost.

1.6.5 Streetlights in Residential Subdivisions OUTSIDE Austin’s City Limits Inside Austin Energy’s Service Area

In areas outside the city limits but inside AE’s service area, upon request, AE will install lights in accordance with the AE Non-Metered Outdoor Lighting tariffs. The requesting party is responsible for the total costs associated with the installation and for monthly energy charges in accordance with the AE Nightwatchman program terms and conditions.

If the request is for a new subdivision, AE will develop a complete lighting plan and coordinate with the developer as to the type of lighting to be installed. The developer is responsible for the purchase and installation of the conduit, AE-approved pull string, pull-boxes, and AE standard streetlight foundations. AE will install the standard poles and fixtures. If the developer prefers streetlight poles other than what is normally installed, the developer and AE will collaborate on the type of pole. This additional cost will also be borne by the developer.

1.6.6 Streetlights in Commercial Areas IN Austin’s City Limits Inside and Outside Austin Energy’s Service Area

Streetlights in commercial areas within the city limits shall be provided by the developer and in accordance with the illumination design provided by AE designers. The fees for commercial streetlighting shall include labor, materials, vehicles, equipment and associated costs of the project. The owner of the commercial development shall pay the entire cost of the installation.

If the new commercial area is in another electric utility’s service territory, as authorized by the Public Utility Commission of Texas, AE will coordinate installation, maintenance and energy charges with the electric service provider for that area.

AE will develop a complete lighting installation plan for new commercial development with installation pursuant to design. The developer shall be responsible for the installation of the conduit, AE-approved pull string, pull-boxes, and AE standard streetlighting foundations. AE will install the standard poles and fixtures. If the developer prefers streetlight poles other than what is normally installed, the developer and AE will collaborate on the type of poles. This additional cost will also be borne by the developer.

Where public streets are installed ahead of the Austin Energy electrical design, site development owners are responsible for paying to install streetlights along these public streets that are within their development. Streetlight costs for these public streets will be included in the design for power to the site.

1.6.7 Streetlights in Commercial Areas OUTSIDE Austin’s City Limits Inside Austin Energy’s Service Area

Streetlights in commercial areas outside the city limits shall be provided by the developer and in accordance with the illumination design provided by AE designers. The fees for commercial streetlighting shall include labor, materials, vehicles, equipment and associated costs. The owner of the commercial development shall pay the entire cost of the installation and monthly energy charges in accordance with the Nightwatchman program terms and conditions.

AE will develop a complete lighting installation plan for new commercial developments and will coordinate with the developer as to the type of lighting to be installed. The developer shall be responsible for the installation of the conduit, AE-approved pull string, pull-boxes, and AE standard streetlight foundations. AE will install the standard poles and fixtures. If the developer prefers streetlight poles other than what is normally installed the developer and AE will collaborate on the type of pole. This additional cost will also be borne by the developer.

1.7.0 TEMPORARY DISTRIBUTION POWER

Section 1.7.0 provides specific requirements and information for temporary overhead and underground Commercial (1.5.2) and Residential (1.5.3) service. For temporary service in the Network Area (1.5.1), contact AE Network Design. (See section 1.18.0 Appendix and Exhibits for examples of various AE metering and temporary service requirements.)

1.7.1 Temporary Service – General Conditions and Requirements

1.7.1.1 Temporary Power Availability

For temporary power, (single-phase or three-phase), AE will provide temporary service where facilities are available or extend AE facilities where AE Design finds is reasonable and practical. Any electric power provided before the Customer satisfies all of the conditions and/or inspections for permanent service shall be considered temporary power and subject to all the costs for temporary power plus any other requirements or conditions deemed appropriate by AE Design.

1.7.1.2 Costs for Temporary Power

The Customer shall be required to pay for the total labor for the installation and removal of all temporary facilities, plus any other costs associated with providing temporary power, the total cost of any non-reusable materials, and any COA fees prior to the installation of temporary power. Contact AE Design. (For temporary power within the Network Area, contact AE Network Design.)

1.7.1.3 Seasonal Service

Temporary service for seasonal business types (such as holiday tree lots or firework stands) shall be removed at the Customer's request or after 90 days at AE's discretion unless the Customer requests a continuance of temporary service from AE Dispatch. The Customer pays the cost indicated in 1.7.1.2 above.

1.7.1.4 Temporary Power Designations

All construction power or temporary power meter loops are designated as either a HBL or a TPL meter loop. All meter loops require a minimum meter can size of 200 amps.

Austin Energy provides temporary construction power to job sites for the duration of 24 months for the sole purpose of construction. If your project exceeds the 24 month period it is the contractor's responsibility is to notify Austin Energy (512) 494-9400 of the need to continue temporary service for an extended amount of time. This should be determined by the contractor. All temporary construction power is disconnected when the permanent meter is installed on the job site. Failure to notify Austin Energy prior to the 24th month of temporary power extension needs may result in a disconnect of the construction power.

- A. **HBL (Home Builder Loop).** HBL loops are construction service single-phase meter loops to be used exclusively for the construction, addition, or remodeling of a single or duplex family residence. Temporary meter loops to be used as HBL loops will continue to require a COA permit and must be inspected by the COA DSD Building Inspections division before their use.
- B. **TPL (Temporary Power Loop).** TPL loops are temporary service single-phase or three- phase meter loops to be used for such things as the construction of triplex and quadruplex family residences and commercial/multifamily building projects, service to temporary offices, buildings, or signs, service to seasonal lots or food stands, and

service to other similar types of temporary applications. This TPL loop, whether new or used, requires a new COA permit and a new COA DSD Building Inspections division inspection before AE will connect to the temporary service. All TPL's require a separate address identifier. Contact Address Management for address identifier prior to submitting the ESPA for review.

- C. For permits (or information) on HBL and TPL permits, please call the Development Service Department or visit Austin Build+ Connect (AB+C) web page. An application for temporary service must also be made to AE for either type of temporary loop.
- D. **Network.** For temporary power in the Network Area, contact Network Design. Temporary power can be provided at 216 volts up to a maximum of 800 amps only if a Network power source is readily available.

1.7.1.5 Interim Service

Interim Service is required for speculative buildings and long-term temporary service.

Where the permanently connected load information and/or the permanent service voltage is not known for various types of speculative buildings (or where service is requested for various types of long-term temporary power that exceed the time limitations of temporary service), the Builder/Customer must take interim service. This requires that service is provided under the conditions of permanent service and that the Customer pay the costs indicated in 1.7.1.2 above for temporary service.

For interim service, AE provides only the facilities and electrical demand capacity required for the interim service for speculative buildings (or for long-term temporary) as determined by AE Design from the Customer's actual interim connected electrical load information. If the builder/developer requests that AE install permanent facilities to serve a speculative building at a load level presumed by the builder/developer before the permanent Customer is known and the permanent electrical demand load can be determined by AE Design, the builder/developer will be charged the cost indicated in 1.7.1.2 above plus the excess facilities cost for the additional facilities and transformer capacity. Should the builder/developer subsequently request additional changes in service capacity or service voltage after the requirements of a permanent Customer are known, the builder, developer, or Customer shall pay all the costs plus any fees associated with these changes.

1.7.2 Temporary Overhead Service

- A. Meter loops shall be wired with a minimum of #8 AWG copper or equivalent unless City code specifies larger conductor due to load requirements.
- B. Meter loops shall be installed on a treated pole that is buried in the ground a minimum of 3 feet and adequately braced to support 400 lbs of service conductor tension (see –section 1.18.0 Appendix and Exhibits).
- C. Meter loops shall have the permanent address posted at the site to clearly identify the service temporary location and have this address clearly marked on the meter loop, meter pole, and/or meter pole braces.
- D. Meter loops shall be installed/located according to these restrictions and clearances when connected to AE overhead facilities:

10-foot minimum	measured horizontally, from AE's facilities (poles and overhead lines) regardless of service size
75-foot maximum	measured horizontally, from AE's facilities (pole serving Customer's facilities) for services rated 225 amps or less
All other maximum service lengths shall be specified by AE Design.	
Customer is responsible for tree trimming activities to allow the safe installation of new electrical facilities by AE. Only AE personnel will trim trees around existing AE facilities.	

See Section 1.10.0 for other overhead service clearance requirements.

1.7.3 Temporary Underground Service

- A. Meter loops shall be wired with a minimum of #8 AWG copper or equivalent unless City code or other governing agency specifies larger conductor due to load requirements.
- B. When connected to underground facilities, the temporary loop shall be installed within 1 foot of an underground service box and have the service address clearly marked on the meter loop, meter pole, and/or meter pole braces.
- C. If the service is to be taken directly from a pad-mount transformer, the temporary meter loop shall be installed within 1 foot of the right-front side of the transformer (pad-lockable side). Direct burial cable shall be furnished and installed in the flexible non-metallic conduit by the Customer. The conduit shall terminate a minimum of 3 inches below grade. The Customer shall connect conductors to the line side (top) of meter base and shall leave a minimum 4-foot tail of cable from the end of the conduit for AE to connect. (See Appendix C - Exhibits, or if in Network Area, call AE Network Design.)

D. Temporary Underground Power

From Single-Phase Pad-Mounted Transformers: The Customer shall provide a 2-inch schedule 80 PVC stub-out, 24 inches deep (to top of the conduit), on the secondary side of all transformer pads for temporary construction power. The Customer shall furnish and install the 2-inch schedule 80 PVC conduit from the stub-out to the Customer's temporary meter loop.

From Three-Phase Pad-Mounted Transformers: The Customer shall use one of the 4-inch schedule 80 PVC permanent service conduit stub-outs on the secondary side of all transformer pads for temporary construction power.

The Customer shall find and expose the 2-inch or 4-inch conduit stub-out at the transformer pad and install the temporary loop within 12 inches of transformer pad. The Customer shall furnish and install the conductors suitable for direct burial from the line side of the Customer's meter base to the transformer pad and leave a minimum 4-foot tail at the exposed stub-out. AE will push the wire up into the transformer secondary compartment and make the connection.

- E. For more information, refer to *Portable Meter Loop for Temporary* in -1.18.0 Appendix and Exhibits and/or contact AE Design.

1.8.0 CUSTOMER ELECTRIC DISTRIBUTION EQUIPMENT REQUIREMENTS

Section 1.8.0 discusses the requirements of the Customer's wiring and the Customer's electric equipment that actually utilizes the electric service provided by AE.

1.8.1 Customer's Wiring, Service, and Electric Equipment Installation

1.8.1.1 New Installations

Customer wiring and electric service shall be inspected by the COA DSD Building Inspections division (and any other authorized inspection entity if located outside of the COA) and (if required by this Design Criteria) inspected by AE or its designee before AE is permitted to connect the service. (See Sections 1.3.0 *Characteristics/Basic Requirements of Electric Service* and 1.4.0 *Requesting/Obtaining Electric Service*.)

HIGHLY RECOMMENDED: In view of the possibility of future additions of electrical equipment, spare capacity for future use should be provided whenever new wiring installations are made. In determining the number and size of service conductors, the estimated ultimate load, as well as the load at the time the wiring installation is made, should be considered. Adequate service facilities should be installed for future additions of lighting, appliances, or motor equipment to avoid expensive modifications later.

1.8.1.2 Modifications to Existing Facilities

To ensure adequate and continuous service, AE Design should be notified before additions or alterations are made to the Customer's electrical installation. Additional Customer wiring shall conform to the NESC and NEC.

Where building alterations or additions make changes necessary in AE's facilities, the Customer's electric service shall be completed and inspected by the COA DSD Building Inspections division, by any other authorized inspection entity if located outside of the COA, and (as required by this Design Criteria) inspected by AE, or its designee, before AE is permitted to reconnect the service. In addition, any change of building usage shall be inspected by the authorized inspection entity, if required, before connection of electrical metering equipment.

1.8.2 Customer's Electric Equipment Load

1.8.2.1 General

The Customer's electric equipment consists of all equipment requiring electric service for its operation. It is in the Customer's interest that all such equipment is of appropriate design, be installed and maintained in accordance with standard practice, and be adequate for the use intended. All apparatus should be selected and used to obtain the highest overall efficiency and lowest overall cost for electric service.

The Customer should consult with AE Design as to the type of equipment to be connected and the capacity, voltage, and a number of phases available at the location where this equipment is to be operated. The Customer must pay any special service requirements necessitated by the Customer's equipment and/or any special Customer requests that constitute excess facilities/extra costs (as determined by AE Design). The Customer must pay these costs before any other excess facilities/extra cost work is started.

1.8.2.2 Motors

- A. **General.** The Customer shall exercise extreme care in the proper selection of motors in order that successful operation and good service will result. Before ordering or installing any polyphase motors (50 hp or larger) or large single-phase motors (15 hp or larger), the Customer shall consult AE Design to determine the character and adequacy of the available service.

After consulting with AE Design, the Customer should ask the manufacturer for advice in the selection and application of motorized equipment and protective devices, so as to secure satisfactory operation at a minimum cost to the Customer, both for the initial installation and for future maintenance.

Single-phase motors to be served with 120/240V supply lines should be connected for 240V whenever practical to minimize voltage drop in the Customer's wiring system and the supply system. All motors shall have a nameplate and voltage rating compatible with the nominal supply voltage. They shall also be designated to operate successfully at rated load with variation in the supply voltage of not more than 10 percent above or below the nameplate voltage rating in accordance with National Electrical Manufacturers Association (NEMA) Specifications.

- B. **Motor Starting Current and Other Special Equipment Requirements.** When planning service, the Customer should consider the current required to start a motor that is appreciably greater than that required for operation at full load after normal speed is reached. While this increase in current is short, it is often enough to cause serious fluctuations in voltage to the Customer using the motor and to other Customers as well. These fluctuations cause objectionable light flickering and disturbances to other types of equipment. Fluctuations that occur only once or twice a day may not be objectionable. However frequently recurring fluctuations of the same magnitude would not be acceptable.

Customers are required to inform Austin Energy about any major loads that might create a voltage sag or flicker during operation. Generally, loads over 50kW/HP are considered to fall in this category. The Customer might be required to take corrective actions to alleviate the service deterioration that may result from the operation of such loads.

If the Customer has primary service of 12.47kV and motor load(s) exceeding 50HP, the following studies shall be performed and IEEE standards satisfied:

1. *Short Circuit and Coordination Study.* A Short Circuit and Coordination Study shall be performed by the Customer to determine how to set protective devices in order to minimize the extent of an outage. The choice of the protective devices shall be determined by the requirement that a fault is interrupted within the effected circuit, thereby, minimizing power disruption. Customer shall perform this study starting from their smallest circuit and working their way back to the main breaker. The main breaker shall fully coordinate with AE's feeder/circuit and substation equipment. AE engineering and technical staff will provide the relay settings for those feeders/circuits as applicable (contact AE Design).

A Short Circuit and Coordination Study is one of the most important tasks that a Customer can perform that ensures the safety and protection of their personnel

and electrical equipment. When an electrical fault or overload causes currents in excess of the interrupting rating of the protective device(s), the consequences can be devastating including injury, damaged electrical equipment, and expensive facility downtime.

The IEEE Electrical Power Distribution for Industrial Plants (Red Book) describes the purpose of Electrical Coordination Studies.

2. *Motor Start Study.* Large electrical motors require a significant amount of current during start-up. (It is not unusual for the start-up current to be six times normal load current). During this startup condition, the voltage may sag to levels that create problems for other equipment operating, or a visual flicker. If this voltage sag is significant (over 3% of the normal voltage at the point of service), the Customer must take corrective action to limit the startup current to minimize the impact on the operation of other equipment and other utility Customers.
3. *IEEE standard 519-1992 or latest version.* The Customer shall perform their calculations based on IEEE standard 519-1992 as the 1st motor to the Nth motor is installed. These calculations shall be based on the initial and ultimate full load, soft starting on initial and ultimate loads, and maximum permissible voltage fluctuation for motors/pumps (maximum of two per hour). The voltage sag must be less than 3% on primary voltage side of utility (12.47kV).

The Customer shall limit the maximum individual frequency voltage harmonics to 3% of the fundamental component and the voltage THD to 5%.

- C. **Polyphase/Single-Phase Motors.** Three-phase service is not readily available in all areas. Before any application of three-phase equipment is made, it is imperative that AE Design is consulted to verify service availability. There is no specific rule on allowable starting currents of polyphase or single-phase motors. Poly-phase motors of 50 horsepower and larger and single-phase motors of 15 horsepower and larger may require installation with reduced-voltage starters.

Starting motors of these 50/15 horsepower and larger motors across the line shall require AE written approval (contact AE Design). The Customer shall be prepared to provide AE Design with all nameplate information from the motor(s) to be installed and all other information required in 1.8.2.2.B in order to determine starting requirements. If this information is unavailable, it shall automatically be assumed that the motor requires reduced-voltage starting.

Protective Devices. All motors shall be equipped with effective protection, installed by the Customer, for the motors, the machines they drive, and the wiring. AE strongly recommends that the Customer's protective devices conform to the requirements of the latest version of the National Electrical Code (NEC).

For example: The NEC requires that when installing three-phase motors, the Customer should use devices to prevent single-phasing (the loss of one phase either in the Customer's facilities or AE supply lines). Regardless of the precautions taken by AE and the Customer, this single-phasing may occur; therefore, the Customer should install equipment to protect the Customer's motor(s). AE is not liable for equipment damage due to single-phasing.

1.8.2.3 Welders, Furnaces, and Such

Electric welders, furnaces and similar short duration high-energy use equipment have inherent operating characteristics that often cause serious fluctuations in the service voltage. The fluctuations affect not only the service of the Customer using the equipment but also the service of other Customers. In some cases, it may be found that the proposed load cannot be served satisfactorily at the specific location unless both AE and the Customer provide special facilities and control equipment. AE, therefore, might be unable to serve the proposed load unless the Customer agrees to provide, at the Customer's expense, the facilities, and suitable control equipment as specified by AE Design.

1.8.2.4 Special Apparatus

Certain types of equipment not covered in this section, such as x-ray machines, radio transmitters, high-frequency apparatus, and other installations, may require special facilities or types of service. Call AE Design before equipment is purchased or installations are made. When a Customer's equipment is not compatible with AE standard services, the Customer shall provide, install, and maintain any necessary devices on the load side of the meter to properly operate and protect this equipment.

1.8.2.5 Radio Antennae

Antennae or aerials for radio or television sets cannot be erected over or under AE supply lines, nor can they be attached to or near AE poles or other equipment. To do so may lead to serious injury to persons and damage to property and may also prevent satisfactory operation of the electronic equipment.

1.8.2.6 Cell Towers

AE will provide only one service to a cell tower. Customer must install an 800-amp single-phase 120/240-volt service entrance (minimum) that will allow for multiple grouped meters that will provide the points of service for multiple Customers (4 minimum) unless the Customer requests a waiver of this requirement in writing and receives a waiver from AE Design in writing (see *section 1.18.0 Appendix and Exhibits*).

1.8.2.7 Computer Equipment

AE does not supply the special power requirements required by some Customer loads such as computers and specialized electronic equipment. The Customer shall provide and maintain necessary equipment on the load side (after) of the metering equipment, which ensures the voltage stability and continuity that the Customer requires for this type of equipment [such as UPS System (Uninterruptible Power Supplies)].

1.8.3 Customer Power Generation Interface with AE

Many variations in AE electrical circuits and a multitude of electrical generator types and capacities (including renewable sources) exist for Customer applications. Therefore, each request for interconnection of Customer-owned power generation/production facilities with the AE system must be individually reviewed and approved by AE. This is to ensure that suitable protective devices will be installed and operating procedures for joint use will be followed.

For more information, contact AE Design and see Section 1.12.0 *Austin Energy's Requirements for Distributed Generation Interconnection (for facilities under 50 kW)* or request a copy of the

1.8.4 Customer's Main Disconnect

The Customer's main disconnect switch(es) shall meet all COA Electrical Code requirements and be located on the load side (behind) and next to the AE meter(s) on the outside of the building at ground level.

- A. Where the Customer is the only Customer served from a transformer, the meter, metering equipment and disconnect shall be grouped together and may be located so that they are accessible from an exterior door located at ground level from outside of the Customer's building. The door must be clearly visible from the transformer location and accessible 24/7 by means of a customer-provided programmable door handle lock (mechanical or digital) installed into the exterior door. The customer's main disconnect switch(es) shall be within 25ft of the exterior door. Also, the Customer shall post a permanent sign on the door with 2-inch letters identifying it as the Electric meter room. See section 1.9.3.2 for meter room requirements.
- B. The meter(s) and disconnect(s) shall be grouped together in a common location. When metered at a transformer, the disconnect shall be grouped with the meter beside the AE transformer or outside the building within line of sight of the AE transformer. (See Section 1.9.3.2 for Meter Room requirements.) If metered at the transformer, the disconnect can be located next to the AE transformer but shall meet all transformer pad clearances. See section 1.10.4.

Note: Emergency Power Off (EPO) devices are accepted by Austin Energy as a means of disconnect and must be installed outside and within line of sight of the AE transformer and labeled as "Austin Energy Disconnect". The label must contain the total amperage of the main disconnect or the total amperage of the combined main disconnects. The label must be an engraved plaque and the print shall be 2 inches in height (minimum). The plaque is to be of contrasting colors (white lettering on either a red or black background) and fastened with machine screws or rivets. EPO device shall be tested when the service is energized for the first time, and then annually after initial energization. Please contact AEDistributionMetering@austinenergy.com.

- C. For maximum number of disconnects and service disconnects, see NEC 230.71
- D. For emergency disconnects, see NEC section 230.85
- E. Metering equipment is sized per the manufacturers maximum nameplate rating of the disconnect, or total number of disconnects, not the fuse size, wire rating or trip/relay setting.

NOTE: Customer upgrades to existing service entrance facilities on the Customer's side of the point of service (such as replacing the main disconnect) shall require that the entire service entrance is brought up to current AE and COA code requirements.

1.8.5 Distribution Service Enclosure (Tap Box, Junction Box) & Wireway Specification

SERVICE DISTRIBUTION ENCLOSURE (SDE, TAP, ENCLOSURE) AND WIREWAY SPECIFICATIONS

- The SDE/tap enclosure and wireway sizes in this section are for minimum requirements. A larger size tap box or wireway may be required depending on circumstances at project location and as determined by the NEC.
- Service Distribution Enclosures (SDE's), or buss type tap boxes which are installed ahead of the metering equipment or ahead of the service disconnect(s) will be sized by the number and size of conduits installed from the transformer, service box, pull-box, etc. or point of service to the SDE/tap box.
- Underground service lateral risers or overhead service risers directly to wire ways or gutters are NOT permitted.
- Minimum SDE/Tap enclosure requirements are listed below:
 - NEMA 3R Hoffman type or equivalent with back plate
 - The front of the enclosure shall be equipped with the following:
 - Overlapping double-doors with 3-point latching system
 - Lift-off hinges
 - Door stop provisions
 - Padlock provision in handle for locking purposes
- Wireways/gutters will be sized based on the size of SDE or tap enclosure .
- Conductor/wire connections are NOT permitted in the wireways.
- SDE or tap enclosures and wireways shall be furnished, installed, owned, and maintained by the Customer.
- For underground installation, SDE tap enclosures shall be installed a minimum of 12 inches and a maximum of 44 inches, measured to the bottom of tap box, above final grade or other accessible surface or working platform.
- For 3 or more metered services, a wireway is required on one or both sides, depending on the number of services.
- The wireway length is per wireway, not the total length of both wireways.

<i>Number and Size of Conduits to SDE, Tap Enclosure From Point of Service</i>	<i>Minimum Tap Box Size or Equivalent Size (inches)</i>	<i>Residential, Apartments, Condominiums Minimum Wireway Size or Equivalent Size (inches)</i>	<i>Commercial Minimum Wireway Size or Equivalent Size (inches)</i>
1-2"	18x18x8	6x6x48	12x12x48
2-2"	18x18x8	8x8x48	12x12x48
1-3"	24x24x10	8x8x48	12x12x48
2-3"	24x24x10	8x8x72	12x12x72
1-4"	24x24x10	8x8x96	12x12x96
2-4"	30x30x12	8x8x96	12x12x96
3-4"	30x30x12	10x10x96	12x12x96
4-4"	42x42x14	12x12x96	12x12x96
5 - 10 -4"	48x48x14	12x12x96	12x12x96

Notes:

- Terminal blocks shall be installed only in the SDE or tap enclosures which is installed ahead of the metering equipment or ahead of the service disconnect(s). Terminal blocks shall meet all applicable ANSI/EIA Standards for electric connectors.
- Terminal blocks shall be installed as per the approved labeling and/or listing and installed with regard to future installations. If a service is to be repaired in existing wireways or existing SDE's or tap enclosures originally installed with split bolt connectors, the split-bolt connectors shall be replaced with terminal blocks.
- Terminal blocks shall be furnished, installed, owned, and maintained by the Customer.
- For commercial installations, SDE or tap enclosure terminal blocks shall be sized to accommodate the Customer's service conductors and the Customer shall terminate the service conductors in the terminal blocks. For installations where the terminations are in the point of service (i.e., pull box), the terminal blocks shall be installed in the pull box. The terminal blocks shall be sized to accommodate the AE's conductors, as determined by AE Design, and AE shall terminate any AE conductors.
- Terminal blocks shall provide sufficient size lugs for the service conductors and generally based on the number of conduits to the SDE or tap enclosure from the AE transformer, etc. (i.e., four 4-inch conduits to the SDE or tap enclosure from the transformer requires minimum of four lugs for each phase conductors and four lugs for the neutral conductors with additional lugs for ground/bond conductors). The Customer shall provide sufficient size and number of terminal blocks to serve all meter sockets, transockets, etc. from the SDE or tap enclosure. The terminal blocks shall provide a minimum of six termination points per phase (e.g., a maximum of six services per wireway) with a minimum of #4 lugs to meet the existing and future (multiple-meter/shell building) service requirements of the building.

1.9.0 METERING

See section 1.18.0 Exhibits and Appendix for examples of AE metering equipment and requirements.

1.9.1 Meters, Metering Equipment, and Metering Services

1.9.1.1 General

- A. **Customer shall** furnish, install, own, and maintain metering equipment of the proper type and capacity for measurement of Customer's electrical power consumption. Where more than a watt-hour meter is necessary to measure electrical power consumption, the Customer shall furnish the appropriate metering equipment.
- All services served by Austin Energy are required to have an ESPA and a City of Austin Electrical Permit for new, repair, re-builds, or upgrades. (see section 1.4.4 or 1.4.5)
 - All metering equipment is sized per the manufacturers maximum nameplate rating of the disconnect, or total number of disconnects, not the fuse size, wire rating or trip/relay setting.
 - All services above 350 amps single phase or 225 amps three phase, are required to be instrument rated.
 - Current transformer enclosures, gutters, and tap boxes shall be used for metering only. No other wiring metered or unmetered will be permitted in the CT service enclosures, gutters or tap boxes.
 - Services with a 400 amp or 600 amp main disconnect or total number disconnects or breakers, are required to be an AE approved transocket unless the service is to be metered at the transformer.
 - ALL instrument rated (CT) services shall have a load side disconnect regardless of voltage.

Exception: Fire Pumps and Solar

- All Fire Pumps, regardless of amperage, are required to be instrument rated.
- The Customer shall furnish and install all meter sockets, voltage transformer packs, CT enclosures, and current transformers (CTs) for permanent and temporary services.
- The Customer shall furnish, install, own and maintain meter pedestals meter packs, and (modular metering) enclosures as reviewed and approved by the AE Advanced Metering Engineering business unit.
aeadvancedmeteringengineering@austinenergy.com
- The responsibility of the Customer is to furnish, install, own and maintain enclosures, wireways, connectors, conduit and fittings, and other miscellaneous materials. This equipment shall conform to the installation requirements of the Austin Energy Design Criteria and NEC.

- Prior to purchasing or installing any equipment, the Customer shall contact AE Distribution Metering Operations for approval of the metering equipment. (aedistributionmetering@austinenergy.com)
 - Austin Energy shall furnish, install, own and maintain the watt-hour meter devices.
- B. Instrument Rated (CT) Inspections
- All instrument rated (CT) services conventional, transocket, network vault, or padmount are required to have a CT inspection.
 - The Customer shall allow up to five (5) business days for the inspection of all instrument-rated metered services, once requested and scheduled through AE Distribution Metering Operations Dispatch (aedmodispatch@austinenergy.com).
 - The Customer shall allow up to five (5) business days for the installation of the metering equipment by AE after the instrument rated (CT) inspection has been approved.

1.9.1.2 Metering Equipment

For approved meter enclosures, CT Enclosures, and CT manufacturers, see the Austin Energy [Website](#).

For CT sizing, contact Distribution Metering Operations at AEDISTRIBUTIONMETERING@AUSTINENERGY.COM.

- A. **For permanent and temporary services, the Customer shall furnish, install, own, and maintain the following equipment including, but not limited to:**
1. Self-Contained Type 200-S meter socket (single-phase and three-phase)
 2. Type 320-SLR meter socket (120/240v, 120/208v), (3 wire single-phase)
 3. Instrument Rated (IR) meter socket enclosure (for instrument-rated services)
 4. Current transformers (CTs) (All window, bushing, and bar type)
 5. Voltage transformer packs.
 6. Potential Transformers
 7. Current transformer (CT) enclosure
 8. Voltage Transformer (VT) Enclosure
 9. AE VT Wiring Harness
 10. Transocket
 11. Ganged-meter socket assemblies: Modular Metering, Meter Packs
 12. Meter pedestal
 13. Service distribution enclosure and all included equipment
 14. Junction box
 15. Wireway(s)
 16. Connectors, lugs, and conductor used for grounding of meters or enclosures
 17. Conduit and fittings for and between the meter and current transformer enclosure
 18. Hubs, when required in-service distribution enclosures, self-contained meter sockets (temporary services).
 19. Terminal blocks (Refer to the table *Junction Box and Wireway Specifications* in Section 1.8.5).
- B. Austin Energy shall furnish, install, own and maintain the following equipment:
1. Watt-hour meter
 2. Metering Cable (For IR installations only).

Contact Austin Energy Distribution Metering Operations business unit for Specifications or written approval of metering equipment and enclosures.
AEDISTRIBUTIONMETERING@AUSTINENERGY.COM

1.9.1.3 Service Conductors in Self-Contained Meter Sockets

- A. Only one conductor (1/0 AWG to 300 kcmil) per terminal shall be allowed in any 200-S meter socket.
- B. Only one conductor (1/0 AWG to 500 kcmil) per terminal shall be allowed in any 320 SLR on the line side. (2) parallel can be allowed on the load side so long as the wire rating is equal to or less than the line side conductor ampacity rating.
- C. The Customer shall make line and load connections in meter sockets, excluding the connection of AE's conductors. Jumpers in a meter socket shall NOT be permitted as a means to provide a Customer with temporary power. At no time shall a Customer's service be connected without an electric meter.

1.9.1.4 Service Connections to Meter Sockets

A. Service Conductors

- 1. Service conductors shall not be extended from one meter socket to supply an additional meter. Conductors supplying several meters shall be branched in a service distribution enclosure or junction box furnished, installed, owned, and maintained by the Customer. Concentric knockouts provided shall be used and shall enter the meter socket in a 4-inch space at the bottom of the meter socket.
- 2. The Customer shall make line and load connections but shall not connect the Customer's service without a meter. For help, contact the AE Service Dispatch business unit so a convenient time for assistance may be set to minimize service outage.

B. Socket-Mounted Transfer Switch Device (Customer-Owned)

Austin Energy allows customers to install approved socket-mounted transfer switch devices within its service territory pursuant to the requirements set forth in City Code Chapter 15-9 (Utility Service Regulations) Section 15-9-177 (Socket-Mounted Transfer Switch Devices). Austin Energy's list of director-approved socket-mounted transfer switch devices is located here: [<link to document>](#)

1.9.1.5 Setting and Removing of Meters

When the Customer is adding, relocating, upgrading, repairing, or otherwise changing a service, only authorized AE personnel shall set and remove meters, except for specific cases authorized by AE, or its designee. Any exceptions shall be obtained at the time the Customer obtains an electric permit. Any electric meter retired from service shall be returned to the Advanced Metering and Systems Engineeringbusiness unit "Meter Shop" 4122 Todd Ln Austin, Tx 78744.

1.9.1.6 Meter Tampering and Seals

Tampering with the meter, metering network, instrument transformers, any conductors carrying un-metered current, or the unauthorized breaking of the Austin Energy seal is prohibited by law.

1.9.1.7 Identification of Customer Meter(s) by Installation Type and Plaque Requirements

- A. Identification for a single meter installation – The meter enclosure shall be labeled with the street address and unique identifier (if applicable)
- B. Identification for a multi-meter installation with a SDE and wireway – The SDE shall have the main address and each meter must be labeled with a unique identifier
- C. Identification for a modular meter installation – The main circuit breaker of the disconnect enclosure shall retain the street address and each meter be labeled with a unique identifier
- D. Permanent paint (minimum 2-inch stencil and spray paint)

Note: Paint pen or marker is not acceptable.

- E. Label or Plaque requirements
 - 1. Labels shall be permanent, weather-proof, have a minimum text height of 2 inches, and shall be an acrylic adhesive or be ultra-violet inhibited.
 - 2. Engraved plaques are acceptable, but the text height must be at least 2 inches. The plaque should be either white lettering on a red background, or white lettering on a black background, and must be fastened with machine screws or rivets.
 - 3. Meter markings for multifamily dwelling units must match the dwelling unit identification.
 - 4. Markings such as front, rear, down, West, etc. are not acceptable.
 - 5. Identification must be shown on the disconnect or meter socket (markings on the glass cover are not acceptable).
 - 6. In residential developments, subdivisions, mobile homes, modular homes, and manufactured home parks, identification shall be done by marking the service disconnect and meter socket (not glass cover) with the lot number.

1.9.1.8 Outdated, Damaged, and Obsolete Equipment

All outdated, damaged, and obsolete metering equipment and meter sockets shall be retired, and electric service upgraded to current code according to one or more of the following criteria as determined by AE staff:

- A. Additional load increases the total load and/or the total load exceeds the ampacity of the meter socket, breaker panel disconnect, Customer's service conductors, main breaker, and/or main lugs.
- B. If the integrity of the service has been changed such as modification from the originally designed system to the service. (i.e. Solar, addition of a main disconnect, generator, or battery).
- C. Service must be final or has been de-energized for non-pay, and no disconnect presently located either outside the building.
- D. Damage to CT's - VT's, Test switches, CT wiring and CT enclosures.
- E. Service has been vandalized and is deemed to have obsolete equipment (i.e... Theft, overhead (CT) racks).
- F. Meter blocks are damaged, burned, or missing.
- G. Service is converted from 2-wire to 3- or 4-wire service or from 3-wire to 4-wire.
- H. Obsolete metering equipment is being used that is no longer available, such as 6-wire metering.

- I. Consult AE Distribution Metering Operations business unit to determine if the metering equipment is obsolete.

1.9.1.9 Current Transformers (CTs) and Enclosures

- A. Instrument Rated Service Types
 - Transocket – All in one enclosure, Combination CT and Meter can
 - Conventional - Separate CT enclosure and Meter can
 - Padmount - CT's are installed on the bushings inside the AE transformer, the meter can is mounted to a separate rack per figure 1.11. See Appendix.
- B. When a Customer's service size exceeds 350 amps single phase or 225 amps three phase, the customer shall use an AE approved transocket (for single phase 120/240v services or three phase - 120/208v services, three phase 120/240v services, or three phase 277/480v services) up to 600A based on the total maximum rating of the manufacturer's nameplate of the main disconnect or disconnects.
- C. When the service size exceeds 600 amps, the customer shall contact AE Distribution Metering Operations business unit so that a representative can determine the capacity and type of CTs to be used. The following requirements apply to the installation and use of CTs and enclosures:
 1. AE Minimum requirements for CT enclosure types as per listed below.
 - a. the Enclosure type NEMA 3R Hoffman type or equivalent with CT mounting bar or back plate that will accommodate either horizontal or vertical mounting. The front of the enclosure shall be equipped with the following:
 - Overlapping double-doors with 3-point latching system
 - Lift-off hinges
 - Door stop provisions
 - Padlock provision in handle for locking purposes.
 - Removable with provisions for pad locking. All manufacturer provided hardware shall be installed.
 - b. Minimum CT enclosure sizes are listed below in Table 1.9.1.9.B

TABLE 1.9.1.9.B MINIMUM CT ENCLOSURE SIZES		
	4-W, 3-Phase, Wye 120/208V 4-W, 3-Phase, Delta 120/240V 3-W, Single-Phase, 120/240V	4-W, 3-Phase, Wye 277/480V
Rating (Amps)	Size (Inches)	Size (Inches)
351-600	AE-Approved Transocket	AE-Approved Transocket
601-1200	36x36x14	42x42x14
1201-1600	42x42x14	48x48x14
1601-2000	48x48x14	54x54x16
Over 2000	Contact Distribution Metering Operations business unit	Contact Distribution Metering Operations business unit

- D. All wire coming and leaving a CT service must be consistent in size and type (Example: 2-500cu on the line side must be 2-500cu on the load side)
- E. A Load side disconnect is required for ALL instrument rated (CT) services. (Exception: Fire Pumps and Solar)
- F. CTs shall be mounted securely in a horizontal or vertical position on the mounting bar provided in the CT enclosure. CTs shall be mounted equal distance apart and centered on mounting bar with polarity point (dot) toward the line side. Aerial CTs are not acceptable. The mounting for CT's on wood shall not be acceptable.
- G. CT enclosures shall be mounted securely on a level surface. A 30-inch minimum and 96-inch maximum height to the bottom of the enclosure shall be maintained from final grade or other accessible surface.
- H. All CT enclosures are built with a top side and a bottom side and must be mounted top side up. If the enclosure is mounted sideways or upside down, the installation will NOT be approved, and the enclosure will need to be replaced and mounted correctly. All Service wire shall be correctly routed through the CT window.
- I. CT Enclosure doors must be able to open at a minimum of 90 degrees and must lock into place via a manufacturer installed door stop or a contractor-installed door stop kit. Supply chain exceptions should be submitted to Distribution Metering Operations at AEDistributionMetering@austinenergy.com.
- J. The CT enclosure shall not be used as a junction box.
- K. Conduit entering at the top of a CT enclosure shall be attached by a welded hub or a rain tight, insulated hub (such as Myers Hub), and approved by the AE Distribution

Metering Operations business unit.

- L. The conduit from the CT enclosure to the meter enclosure shall be rigid metal conduit or Schedule 80 PVC conduit. It shall have a 1-1/4-inch minimum inside to 1-1/2 inch maximum diameter and a minimum length of 4 inches and a maximum length of 40 feet.

Note: For runs greater than 40 feet, contact the AE Distribution Metering Operations business unit.

- M. For side-by-side applications use only straight nipples. Offsets are not allowed.
- N. There shall be a #6 AWG copper conductor for case grounding from the CT enclosure to the meter enclosure. This ground must be connected to the building ground or a driven ground and run inside a conduit only, not external to either enclosure.
- O. When using a transocket for three phase 277/480v services, a 2.5:1 VT pack, wiring harness, and VT enclosure shall be required. There shall be a #6 AWG copper conductor for case grounding, from the transocket to the VT enclosure. This ground must be connected to the building ground or a driven ground run inside conduit only, not external to either enclosure.
- P. The VT enclosure must be mounted not more than 72" from final grade to the bottom of the enclosure. With a minimum height of 30" from final grade to the bottom of the enclosure. Use straight nipples only, no offsets allowed. The VT enclosure must be mounted within 12" of the transocket or meter enclosure.
- Q. No more than two 90-degree bends and two condulets (LL-LB-LR) at meter enclosure or corner of the building shall be permitted.
- R. Requests for the use of non-approved CT enclosures will need to be submitted to AE Distribution Metering Operations for review prior to procurement.
- S. Current transformers (CTs) and/or Voltage transformers (VTs) shall not be allowed inside customer switchgear for revenue metering purposes.
- T. Existing CT installations located inside a customer's switchgear and requiring upgrades or modifications must meet the following:
- Fed from a dedicated pad-mounted transformer: Must now be metered at the pad-mounted transformer
 - The pad-mounted transformer feeds multiple customers: The service must now be rebuilt on the external wall of the building. This includes relocating or adding a new main disconnect, as the meter/meter equipment/disconnect must be grouped together.
- U. When pulling conductors through window type CTs, the conductor' colors shall be installed per Table 1.3.7. If the wiring installation has more than one conductor per phase, the same conductor color must go through each CT (Example: all red conductors through the 1st CT; all black conductors through the 2nd CT, and so on.)
- V. All conductors shall be phased on both sides of the current transformers (CT's) unless

the color coated wire is used.

- W. Instrument-rated meter installations must be inspected by the AE Distribution Metering Inspections business unit before the meters are set and the service energized.

1.9.1.10 Metering Large Capacity Services

Metering of large power installations (above 1200 amps) requires special and individual consideration by both the Customer and AE. When planning any such as installation, the Customer shall consult with and receive written approval from the AE Distribution Metering Operations business unit.

1.9.1.11 Application of Metering Equipment

Table 1.9.1.11 provides the requirements for meter sockets and enclosures as follows:

TABLE 1.9.1.11 METER SOCKETS AND ENCLOSURES										
SOCKET OR ENCLOSURE TYPE			CONDUCTOR TYPE & SIZE (AWG)							
	APPLICATION		Residential				Commercial			
			Copper		Aluminum		Copper		Aluminum	
	<i>Phase</i>	<i>Max Amps</i>	<i>Min</i>	<i>Max</i>	<i>Min</i>	<i>Max</i>	<i>Min</i>	<i>Max</i>	<i>Min</i>	<i>Max</i>
200-S	Single	225	1/0	3/0	3/0	250	2/0	4/0	4/0	300
200-SP	Three	225	1/0	4/0	2/0	300	1/0	4/0	2/0	300
320-SLR 120/240V only (UG – 3” conduit)	Single	350	4/0	400	300	600	4/0	500	300	500
	Multiple (Written approval from AE Distribution Metering Operations business unit)		1/0	1/0	1/0	3/0	1/0	2/0	1/0	3/0
Instrument Rated Meter (IR) Socket)	For services where CT-rated, socket-type metering equipment is used									
Ganged-Meter Socket Assembly (Modular Metering), Meter Pedestal	Furnished, installed, owned, and maintained by Customer. Prior to purchasing and installation, contact the AE Advanced Metering Engineering business unit for an approved list. Aadvancedmeteringengineering@austinenergy.com									

Note: The main disconnect or any parallel combination of disconnects or service switches shall not exceed the rating of the meter socket or the meter. All self-contained meter sockets shall be ringless with locking jaw lever bypass. See the AE website for approval details and specifications.

1.9.1.12 Primary Metering

See Section 1.5.2.7 Primary Voltage Service.

1.9.1.13 Load Profile Services

For consumption and demand information via AE's password protected website, AE can provide wireless communications at an additional cost. For additional information, contact AE's Key Account Management (keyaccounts@austinenergy.com).

1.9.2 Clearances and Mounting Heights for Metering Equipment and Enclosures

- A. A minimum 2-inch installation clearance shall be maintained on all sides of meter sockets, transockets, and metering enclosures.
- B. In addition, the minimum working clearances for metering equipment and enclosures shall be as follows:
 - 1. Front working space: 30-inch-wide, or width of equipment, whichever is greater (centered on equipment)
 - 2. 36 inches in front (direction of access measured from the face of the meter socket)
 - 3. 6-foot 6-inch headroom.
- C. Minimum and maximum mounting heights measured from final grade or other accessible surfaces shall be as follows in Table 1.9.2.C.
- D. Minimum of 1 ft. from all exterior openings (i.e., door frames and windows).
Note: If the door hits the meter when it opens, a bollard or protective barrier shall be put in place to prevent the meter from being damaged, or the customer must relocate the meter for the door to clear the electric meter.

TABLE 1.9.2.C		
MOUNTING HEIGHTS FOR METERING EQUIPMENT AND ENCLOSURES		
Height Measured from Final Grade or Other Accessible Surface to:	Minimum/Maximum (inches)	Socket or Enclosure
Center of Meter Socket Opening	30 / 72	200-S Single Phase 200-S Three Phase 320-S Single Phase Meter Pedestal Modular Metering Packs
	48 / 72	Transocket Instrument Rated Meter (IR) Sockets
	30 / 72	Modular Metering

1.9.3 Installation of Metering Equipment

1.9.3.1 Location of Meter Sockets, Transockets, CT Enclosures, and Meter Centers

- A. Meter sockets, transockets, enclosures, and meter centers shall be outdoors and be readily accessible for reading, testing, and other maintenance.
- B. All meter location(s) shall be on the first floor or ground level and shall be within of sight of an AE transformer. (AE Design and Distribution Metering business unit must approve meter location exceptions in writing.) Specific written approval of AE Design is required to locate meters inside or behind any type of door.
- C. Electric meters shall not be installed in any of the following locations:
 - 1. On or under porches, stairways, or similar structures
 - 2. Under overhangs (overhead services only), carports, or similar structures that exceed 72 inches
 - 3. Where moving objects might damage the metering equipment
 - 4. Within a circle radius of 3 feet of gas meters, regulators, relief valves, and electrical apparatuses.
- D. It is the Customer's responsibility to see that the meter location remains the same as constructed and to keep the area below and in front of the meter location clear of debris, such as: refrigeration equipment, trash boxes, landscaping, or any other obstructions that would affect the access and safety of AE personnel working on the equipment.
- E. The meter may be placed behind doors for appearance or protection only with written approval from the AE Design. NOTE: As per the City of Austin Ordinance and as an AE

requirement, AE must have 24/7 safe and unobstructed access to all AE facilities, including but not limited to transformers, poles, meter enclosures, CT enclosures, ect.

- F. The Customer shall provide a programmable door handle lock (mechanical or digital) installed into the exterior door to AE specifications. The Customer shall post a permanent sign on the door with 2-inch letters identifying it as the door to the Electric meter room.
- G. When the meter socket, transocket, CT enclosure, and service equipment locations are subject to the 100 Year Reference Flood Datum ordinance, they must be a minimum of 1 foot above flood level, measured to the bottom of the meter socket or enclosure, as required by the Spot & Conduit business unit (single-phase services) or AE Design (three-phase services).
- H. Some circumstances may require the Customer to furnish, install, own and maintain a permanent structure for access to the meter socket, transocket, meter enclosure, CT enclosure, and service equipment. Before installing a permanent standing surface or platform (30-inch width and 36-inch depth minimum, NEC 110.26), the Customer shall provide an engineered drawing of the proposed structure and obtain written approval from AE Design for the design and type of materials to be used. The permanent standing surface shall be accessible by stairs (not ladder) and be inspected and approved by AE Design, or its designee.
- I. The meter(s) and disconnect(s) shall be grouped together in a common location. When metered at a transformer, the disconnect shall be grouped with the meter beside the AE transformer (but adhere to the transformer clearances (see section 1.10.4)) or outside the building within line of sight of the AE transformer. (See Section 1.8.4 for main disconnect requirements.)
- J. The maximum distance allowed between a meter and a disconnect is 20 feet. The meter and disconnect must be within line of sight of each other and readily accessible, or as determined by AE Distribution Metering Operations.

1.9.3.2 Meter Rooms

A meter room is a weatherproof, illuminated room provided by the customer and used to enclose electric service and metering equipment inside a building. Meter rooms are allowed upon Customer's compliance with the following requirements and written approval by AE Distribution Metering business unit:

- A. Locations
 - 1. Meter room(s) must have one exterior wall and be accessible from outside the customer's building to AE personnel from an exterior door located at ground level. The door must be clearly visible from the transformer location.
 - 2. For meter rooms located inside a "High Rise" building, the location of the meters may be located on upper floors or above-grade garages and must be approved by AE Distribution Metering Operations business unit.

3. For a building to be considered as a "High Rise", the building must be a building with an occupied floor located more than 75 feet (22,860 mm) above the lowest level of fire department vehicle access.

B. Access

1. All access doors must be accessible 24/7 and shall not be located behind an access gate or fence/roll up gate.
2. Meter room(s) located on a first floor shall have access from a door located on the building exterior wall opening directly into the meter room or, when approved by the AE Distribution Metering business unit, from a door opening directly into the meter room from a public area or hallway. Where a second access door is provided, the door shall not exit into any occupancy. The access door to the meter room must be within line of sight of the nearest AE transformer.
3. Meter rooms located on garage levels shall have access doors opening directly to the garage or parking area.
4. Meter rooms in high-rises may be located on an upper-level floor and shall have stairs of normal tread and rise and be located near an elevator.

C. Doors

1. Entrance to the meter room(s) must be through a doorway not less than 30 inches wide and 6 feet-6 inches high.
2. Doors must be designed to open outward from the room and be equipped with lever-actuated, safety hardware. If this is not practical in AE's judgment, doors may be permitted to open into the room provided the doors are:
 - a. Equipped with devices to hold the door in the open position.
 - b. Located so the doors will not open into the meters or obstruct any required working space.

Note: ROLL-UP DOORS AND TOP-HINGED DOORS ARE NOT ACCEPTABLE.

D. Locking Provisions

1. When the meter room is to be locked, the customer shall install a programmable door handle lock (mechanical or digital) installed into the exterior door to AE specification.
2. The programmable door handle lock must be programmable by AE personnel.

E. Identification

1. Each meter room door shall be provided with a permanent sign reading "ELECTRIC

METER ROOM" with 2-inch letters.

2. Where more than one-meter room or location is provided, the sign shall identify each location by number (i.e., "1 of 2" and "2 of 2") and shall include a map of the building showing the other meter locations and areas controlled by each location.
3. The sign shall be metal or plastic with engraved or machine printed letters, or electro-photo plating, in a contrasting color to the sign and shall be attached with screws, pop-rivets or epoxy.

F. Foreign Equipment

1. Cable television, telephone, and other communications installed in the meter room shall not obstruct working and access clearances to the electric service and metering equipment.
2. The meter room shall not be used for storage or warehousing purposes.
3. The following equipment shall not be permitted within the meter room:
 - a. Gas equipment – including piping.
 - b. Water heaters or boilers.
 - c. Security alarm systems connected to the access doors that operate when entry is made to the meter room.
 - d. Batteries and battery charging equipment.
 - e. Any other equipment or facilities judged to be unacceptable by the AE Distribution Metering Operations business unit.

G. AMI Communication

1. The customer shall conduct a pre-assessment of communication signal strength through AE's AMI network provider.
2. The customer shall purchase, install and maintain any and all communication equipment required by the meters to communicate to AE's AMI network provider/
3. If Austin Energy's AMI network provider has any difficulty in reading the meters after installing and energizing the meters, then the customer shall, at the

customer's sole cost and within 30 days of receipt of such notice from AE. Relocate the meters to a different location that is approved in advance by AE Distribution Metering Operations business unit.

4. If Austin Energy's AMI network provider has any difficulty in reading the meters after installing and energizing the meters, the customer agrees to reimburse AE for all the cost incurred by AE in manually reading the meters. The Customer must make the reimbursement within 30 days of receipt of AE's invoice for manual reading costs.

1.9.3.3 Mounting of Meter Sockets, Transockets, and Enclosures

- A. Meter sockets, transockets, meter enclosures, Voltage Transformer enclosures, and CT enclosures shall be securely mounted level and plumb on the exterior finished surface of the building or structure, using only the mounting holes provided. Where meter sockets, transockets, meter enclosures, Voltage Transformer enclosures, and CT enclosures are attached to masonry or concrete walls, approved expansion bolts or anchors shall be used. Wood plugs or plastic anchors are not acceptable.
- B. The meter socket should be mounted on the exterior finished surface of a building or structure and be within line of sight of the nearest AE transformer.
- C. If the meter enclosure is mounted inside of a building, closet, or behind locked gates, the AE Distribution Metering Operation business unit must be consulted and must approve the installation.
- D. Service conduit shall be exposed on the exterior finished surface of the building or structure.
- E. When running conduits into the meter enclosure, run the conduit into the factory-punched knock-outs only. Do not cut any holes in the meter enclosure. If holes are cut in the meter enclosure, AE will consider it damaged and will not approve the installation. AE will require the damaged enclosure to be replaced with a new one at the Customer's cost. Resealing the holes will not be acceptable.
- F. Identification of Customer's Meters' according to Section 1.9.1.7 is required for all meter installations. When desired, meter sockets, transockets, and enclosures may be painted for aesthetic purposes.

1.9.3.4 Grouping of Meters

- A. Where two or more meters are installed at one location and served from one set of service conductors, a service distribution enclosure (SDE) and wireway must be used to connect the enclosures or sockets. See additional SDE information in appendix.

- B. Only line conductors are permitted in the service distribution enclosure, junction box, or wireway. Meters and mains served from one spot location must be grouped and marked. (See *Identification of Customer Meters, 1.9.1.7* in this section.)

1.9.4 Submetering – Residential and Commercial

1.9.4.1 Definitions

In this section:

“Apartment house” means one or more buildings containing six or more dwelling units, each of which is rented primarily for non-transient use with rent paid at intervals of one week or longer. The term includes a rented or owner-occupied residential condominium building.

“Dwelling unit” means one or more rooms suitable for occupancy as a resident and that contain kitchen and bathroom facilities, or a mobile home in a mobile home park.

“Owner” means any owner, operator, or manager of any apartment house, mobile home park, small multi-unit housing development, or commercial development engaged in electric submetering.

“Small multi-unit housing developments” means any multi-unit residential building or buildings comprising five or fewer dwelling units.

1.9.4.2 Approval

“Submeter” means to allocate fairly the cost of the electrical usage of each dwelling unit in an apartment house, mobile home park, or small multi-unit housing development, or each commercial unit in a commercial development through the use of submetering equipment.

Apartment houses and mobile home parks: Pursuant to the requirements of Texas Utilities Code Sections 184.013 and 184.014 and any applicable rules adopted by the Public Utility Commission of Texas, the owner of an apartment house or mobile home park may submeter each dwelling unit in the apartment house or mobile home park to measure the quantity of electricity consumed by the occupants of each dwelling unit.

Commercial units and small multi-unit housing developments: The owner of a commercial unit or a small multi-unit housing development must obtain written approval to submeter each commercial unit or dwelling unit from the AE Distribution Metering Operations business unit. Approval will be based on compliance with the requirements on submetering in City Code.

1.10.0 CLEARANCE AND SAFETY REQUIREMENTS

For ease of reference, Section 1.10.0 is a collection of the various clearance requirements and information concerning temporary working clearances from AE distribution facilities during the construction phase of the Customer's facility and concerning the final permanent clearances of the Customer's facilities from AE overhead, underground, and pad-mounted distribution facilities (see sections 1.4.0, 1.5.0, and 1.9.0.). For transmission and substation requirements, refer to Section 1.14.0.

1.10.1 Safety

At all times during construction and maintenance (including temporary or permanent facilities), the Customer shall use proper procedures complying with all building codes, State laws, the NEC, NESC, and federal laws, including OSHA requirements.

1.10.2 Minimum Working Clearances from Energized Overhead Electric Utility Lines

- A. **Strict compliance with Texas law and OSHA is mandatory:** OSHA 1910.333 prohibits all activities in which unqualified persons or things may come within 10 feet in any direction of live overhead lines with a voltage to ground of 50kV or below, or within 10 feet plus 4 inches for every 10kV over 50kV. This applies both to AC and DC voltages. Chapter 752 of Texas Health & Safety Code has similar restrictions.

The operation of equipment such as a crane, derrick, drilling rig, hay loader or similar equipment—any part of which is capable of vertical, lateral, or swinging motion—is forbidden by OSHA requirements (see OSHA 1926.1400, including 1926.1408) to operate within certain distances based on line voltage in any direction of live overhead high-voltage lines. Contractors and owners (not AE) are legally responsible for the safety of construction workers under this law, which carries both criminal and civil liability.

- B. **Notification Requirement.** The Texas Health and Safety Code, Chapter 752, Section 752.003 requires that the owner, contractor, or association responsible for temporary work in the vicinity of high-voltage electric lines must notify the operator of the line (Austin Energy) at least 48 hours before the work begins. No work can begin until the persons responsible for the temporary work and the operator of the line (Austin Energy) have made satisfactory arrangements to de-energize and ground, move or relocate the line to prevent accidental contact.

Figure 1.10.2A - OSHA Working Clearances from Overhead Lines for Unqualified Persons

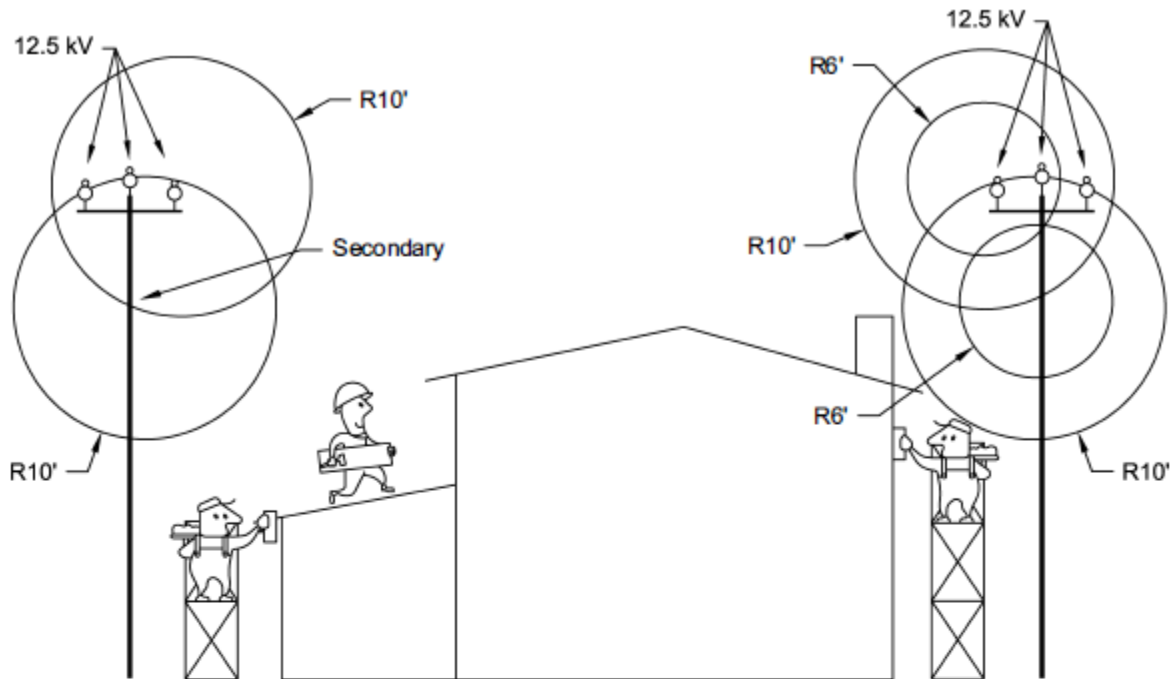

1. OSHA 1910.333(c)(3)(i)(A/A1), 1910.333(c)(3)(i)(B)

When an unqualified person is working in an elevated position near overhead lines (or on the ground in the vicinity of overhead lines), the location shall be such that the person and the longest conductive object he or she may contact cannot come closer to any unguarded, energized overhead line than.... 10ft.

2. Texas State Health & Safety Code 752.004. RESTRICTION ON ACTIVITIES NEAR LINES. (a) Unless a person, firm, corporation, or association effectively guards against danger by contact with the line as prescribed by Section 752.003, the person, firm, corporation, or association, either individually or through an agent or employee, may not perform a function or activity on land, a building, a highway, or other premises if at any time it is possible that the person performing the function or activity may: (1) move or be placed within six feet of a high voltage overhead line while performing the function or activity; or (2) bring any part of a tool, equipment, machine, or material within ten feet of a high voltage overhead line while performing the function or activity.

3. The workers, scaffolding, and anything in the workers hands must stay out of the appropriate working clearance circles (10' radial clearance from any energized wire).

1.10.3 Permanent Clearances from AE Overhead Distribution Lines and Facilities

The Customer's facilities/installations shall maintain clearances from AE electric distribution overhead facilities as required in Section 234 of the NESC. In addition, the Customer's facilities shall not be installed under or over AE overhead distribution facilities and shall maintain a minimum horizontal sky-to-ground clearance of 7 feet-6 inches from overhead primary, neutral, and secondary conductors and a 15-foot-radius clearance from overhead distribution primary and neutral conductors (see representation drawing below). Additional clearance and access easements may be required by Austin Energy to ensure accessibility to safely maintain AE infrastructure.

See the NESC and Austin Energy Permanent Clearance Envelopes in the diagram below. (Also see Section 1.10.6 for service drop clearances and Section 1.10.7 for clearances from swimming pools). These include, but are not limited to, clearances from Customer's buildings, parking garages, light poles, signs, billboards, chimneys, radio and television antennas, tanks, and other installations. As required by AE Design, the Customer shall provide AE with a survey showing the proximities of the Customer's existing and/or proposed facilities to existing AE primary voltage facilities. For more information, contact AE Design.

["Drawings to Help Determine Buildable Areas Outside of AE Clearance Envelopes"](#) can be found on the Austin Energy website.

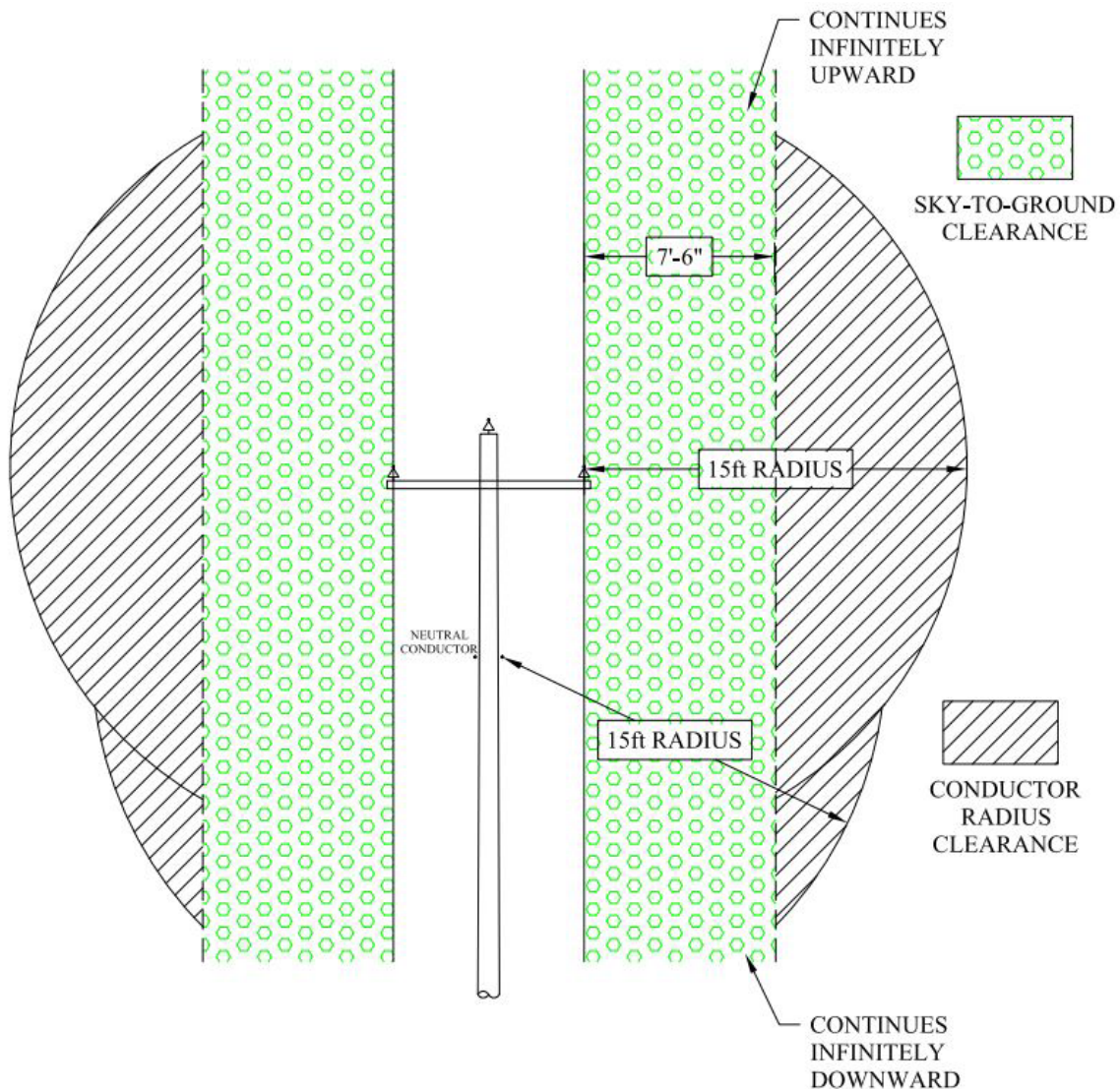

1.10.4 Clearances from AE Padmount Equipment and Distribution Vaults

Minimum clearances required for all padmount transformer pads and other pad-mounted electrical equipment as required by the AE Distribution Design business unit are listed in Table 1.10.4 and illustrated in the following figure. Clearances are applicable only to brick or masonry structures with a minimum 2-hour fire rating except as noted. For additional information on clearances from AE facilities and equipment, contact AE Design.

TABLE 1.10.4 MINIMUM CLEARANCES FROM PADMOUNT EQUIPMENT PADS AND DISTRIBUTION VAULTS^{1, 3, 4}		
Hot-stick-use area (pad-locked sides) of all AE equipment, such as transformers and switchgear	10 ft	Open area or clearance to adjacent building or structure
Hot-stick use area of all AE equipment such as transformers and switchgear)	15 ft	Facing a confined space such as a niche or vault.
Sides without operators or controls	03 ft	Open area from any removable ventilated obstruction (fence)
Sides with operators or controls	05 ft	Open area from any removable ventilated obstruction (fence)
All sides	20 ft	Horizontal/radial clearance from the edge of oil-filled equipment pad to fire escape or stairs that serve as a fire escape
Any side when the pad is adjacent to brick or masonry building or structure	05 ft ²	Minimum horizontal clearance from side edges of equipment pad to building or structure.
Any side when the pad is adjacent to brick or masonry building or structure	05 ft	Minimum lateral clearance from the edge of the pad for windows, doors, and ventilating ducts.
Any side when the pad is adjacent to NON brick or masonry building or structure	12 ft	Horizontal clearance from the edge of oil-filled equipment pad to NON brick or masonry building or fixed structure
Any side when the pad is adjacent to windows, doors, or ventilating ducts	12 ft	Vertical clearance from grade for windows, doors, and ventilating ducts when lateral clearance is less than 5 feet from oil-filled equipment pad.
Any side when the pad is adjacent to windows, doors, or ventilating ducts	12 ft	Horizontal clearance from the edge of oil-filled equipment pad to building or fixed structure, if a window, door, or ventilating duct is less than 12 ft from grade or has less than 5 ft of lateral separation.
Vertical clearance above the pad and the total minimum clearance area surrounding the pad	NO	No covering, building, or structure of any kind is allowed directly above the pad or the minimum equipment area associated with the pad. ³
<p>Equipment pads must be located within 6 feet from parking/traffic areas for AE truck accessibility unless otherwise specified by AE Design. Also, when the equipment pad is installed within 4 feet of parking/traffic areas, 4-inch minimum galvanized rigid metal posts (bollards) must be installed as indicated on equipment pad details from AE Design. Bollards must be spaced from equipment to allow for opening of equipment doors. Equipment pads must be 2 feet from back of sidewalks. Transformer pads cannot be placed near flammable liquids.</p>		

1 For oil filled pad-mounted equipment, liquid flow for the area surrounding the equipment should always be away from the building.
2 May be reduced to 3 feet (with AE Design written approval) for the clearance from one side of the pad (side without pad-lock, operators, or controls) only if the lateral clearance to the pad is not in a confined space, such as a niche or a vault, is 10 feet or more to windows, doors, or ventilating ducts, and only if vertical clearance to the pad is 15 feet or more to windows, doors, or ventilating

ducts. The 3-foot clearance is applicable only to structures with a minimum 3-hour fire rating in the clearance area.

- 3 AE may provide electric service from a specialized niche that is accessible from outside of but located within the footprint of the Customer's building or structure. Niche service requires that all AE equipment be totally accessible by truck or other suitable AE equipment for installation, operation, and maintenance purposes. Clearance requirements around the equipment shall be in accordance with the latest Austin Energy Construction Standard and maintain a minimum 35-foot vertical clearance inside the niche and the niche entrance. All walls and ceilings of the niche must have a minimum 3-hour fire wall and be properly ventilated. The entrance and area in front of the equipment shall remain free and clear as per standard services. Consult with the Austin Energy Design business unit for the design of the niche.
- 4 All padmount/vault/niche equipment must be installed on the Customer's property, not in public ROW. All equipment and vaults must be locked with an AE lock and accessible only to AE personnel.
- 5 The clearance specifications provided in this table do not apply to shrubbery and other forms of landscaping, including trees. The clearance requirements for the placement of trees and landscaping near pad-mount equipment is provided in Section 1.10.10.4.

EXAMPLE: MINIMUM CLEARANCES FROM PADMOUNT TRANSFORMER PAD

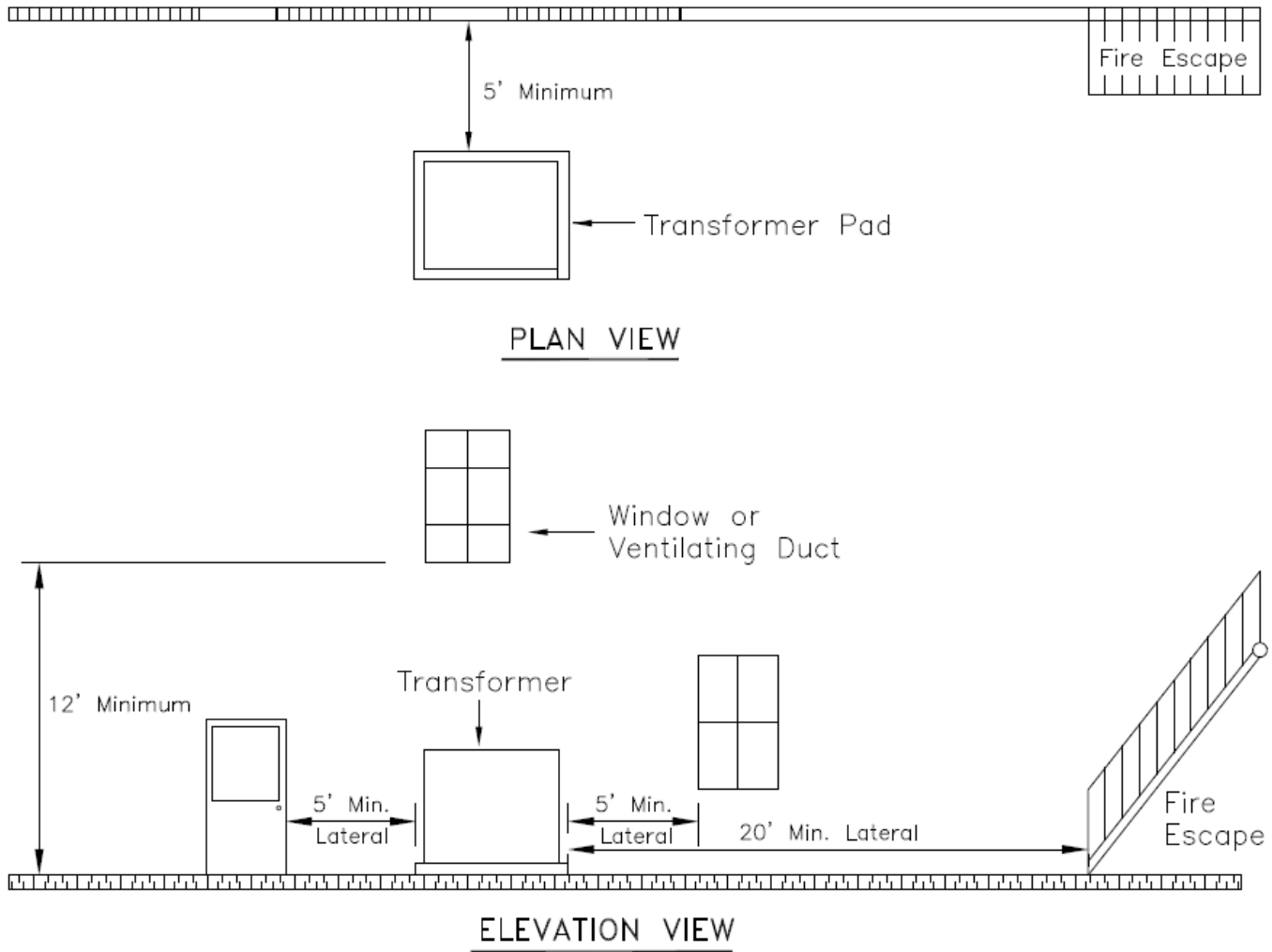

1.10.5 Clearances for AE Underground Cable, Conduit, and Underground Facilities

A. Clearances from the underground facilities of other utilities are as follows:

12-inches minimum	Measured both horizontally and vertically (crossing perpendicularly only) from AE's underground facilities (cable, conduit, duct structure, pull-boxes, and such) to other utilities other than gas lines, fuel lines, or steam lines. Joint trench is permitted with other utilities only by written agreement with AE. Communication conduits are not allowed over AE main line duct banks (see main line definition in glossary.)
36-inches minimum	Measured both horizontally and vertically from AE's underground facilities (cable, conduit, duct structure, pull-boxes, and such) to fuel lines and high pressure gas pipelines (60 psi & over)*
24-inches minimum	Measured horizontally from AE's underground facilities (cable, conduit, duct structure, pull-boxes, and such) to gas pipelines (less than 60 psi)
6-inches minimum	Measured vertically from AE's underground facilities (cable, conduit, duct structure, pull-boxes, and such) to gas pipelines (less than 60 psi)
36-inches minimum	Measured vertically from AE's underground facilities (cable, conduit, duct structure, pull-boxes, and such) to steam lines.
12-inches minimum	Measured vertically, from AE's facilities (cable, conduit, and such) where other UG utilities cross AE UG facilities. In addition, any AE conduit must be encased in a minimum 2-inches of concrete for a minimum of 24 inches on either side of crossing if and as required by AE Design.

*Requires 3-in concrete encasement of AE conduit for 36 inches on both sides of crossing when AE conduit is installed above the other utility conduit.

B. Clearance from Customer building, foundations, or other permanent structures is as follows:

60-inches minimum	Measured horizontally from AE's underground facilities (conduit, duct structure, pull-boxes, manholes, and such). No Customer building, foundation, or other permanent structure shall be installed over AE underground facilities. Variations permitted for customer-installed AE vault installations or by written permission from AE Design. At AE's discretion, conduit may pass through a retaining wall (below grade), but a license agreement is required. The conduit must be installed in a metal sleeve of sufficient size that allows the AE conduit to be replaced without damage to the wall or wall footing, and must pass through the wall perpendicularly and extend one inch past the wall and wall footing. It is the property owner's responsibility to maintain the wall. Austin Energy requires engineering drawings sealed by a professional engineer as required by the City of Austin Utility Criteria Manual. (Clearance required for swimming pools. See 1.10.7)
--------------------------	--

1.10.6 Clearances for AE Facilities from Customer’s Service Entrance Facilities

1.10.6.1 General

The Customer's service entrance facilities (such as service equipment, service conductors, one-point rack) for permanent and temporary services shall be installed according to the following:

10-foot minimum	measured horizontally, from AE's facilities (poles and overhead lines other than the service drop) regardless of service size
------------------------	---

1.10.6.2 Service-Drop Conductor Clearances

- A. **Clearances/Attachment Heights.** NESC (Section 23) along with AE Distribution Design and Construction Standards require minimum clearances for service-drop conductors from final grade or other accessible surfaces, which shall be maintained at all times. To facilitate these clearances, minimum attachment heights shall be as listed in Table 1.5.3.3.C.2. For more information, contact AE Design.
- B. All clearances shall comply with rules and exceptions as stated in the NESC.

TABLE 1.5.3.3.C.2 VERTICAL CLEARANCES AND ATTACHMENT HEIGHTS FOR RESIDENTIAL AND COMMERCIAL SERVICE-DROP CONDUCTORS COMMERCIAL SERVICES			
	<i>Minimum Clearance From Final Grade/ Other Accessible Surface (Feet)</i>	<i>Attachment Height¹</i>	
		<i>Minimum (Feet)</i>	<i>Maximum² (Feet)</i>
Residential services over areas accessible to pedestrians only.	12	12.5	15
Services passing over residential driveways, or parking lots and alleys (not subject to truck traffic). Commercial services over areas accessible to pedestrians only.	16	16	18
Services passing over roads, streets, alleys, parking lots, subject to truck traffic or other land such as cultivated, grazing, forest, orchards, etc. traversed by vehicles	18	18	21
A minimum clearance above the roof of 3 feet shall be permitted for service-mast installations, including but not limited to service-mast (through-the-roof) installations, where the voltage between conductors does not exceed 300V.			

Where the voltage between conductors does not exceed 300V and the mast is located within 4 feet of the edge of the roof and above only the overhanging portion of the roof, a minimum clearance of 18 inches shall be permitted for service-mast (through-the-roof) installation. No more than 10 feet of service-drop conductors may pass above the roof overhang.

No more than 6 feet of service-drop conductors may pass over the roof.

- 1 The Spot & Conduit business unit (for single-phase services) or AE Design business unit (for three-phase services) may approve an attachment height, other than those listed in this table, based on the circumstances at the site location. However, minimum attachment height shall be maintained at all times to meet NESC requirements.
- 2 Attachment heights should in no case exceed the maximum as listed unless approved in advance by AE Spot & Conduit business unit (for single-phase services) or AE Design (for three-phase services).

1.10.7 Clearances from Swimming Pools, Hot Tubs, Saunas, and Man-Made Retention Ponds

- A. A minimum 10-foot clearance measured horizontally is required from any AE overhead distribution facilities to the water's edge of swimming pools, the base of diving platforms, hot tubs, spas, anchored rafts, and such (See section 1.18.0 Appendix – Figures 1-34 and 1-35).
- B. A minimum 10-foot clearance measured horizontally is required from any AE overhead distribution facilities to the water's edge of man-made retention ponds constructed from materials such as concrete.
- C. A minimum 10-foot clearance to AE underground distribution facilities (transformer, pull box, etc.), or a 5-foot clearance to underground conduits and conductors, measured horizontally, is required to the water's edge of swimming pools, man-made retention ponds, the base of diving platforms, hot tubs, spas, anchored rafts, etc.
- D. The AE electric meter (mounted on building or structure) must be located at least 5 feet, measured horizontally, from the water's edge of swimming pools, man-made retention ponds, hot tubs, spas, or similar structures.
- E. If any of the above Customer facilities are installed between AE's last designated facility and the Customer's service/meter location or closer than minimum clearances given, any additional AE facilities, material, and/or labor required to maintain the minimum clearance shall be at the Customer's expense. Any relocation shall be at the Customer's expense.

Figure 1.10.7A - Clearance from Water Holding Facilities to Overhead Electric Facilities

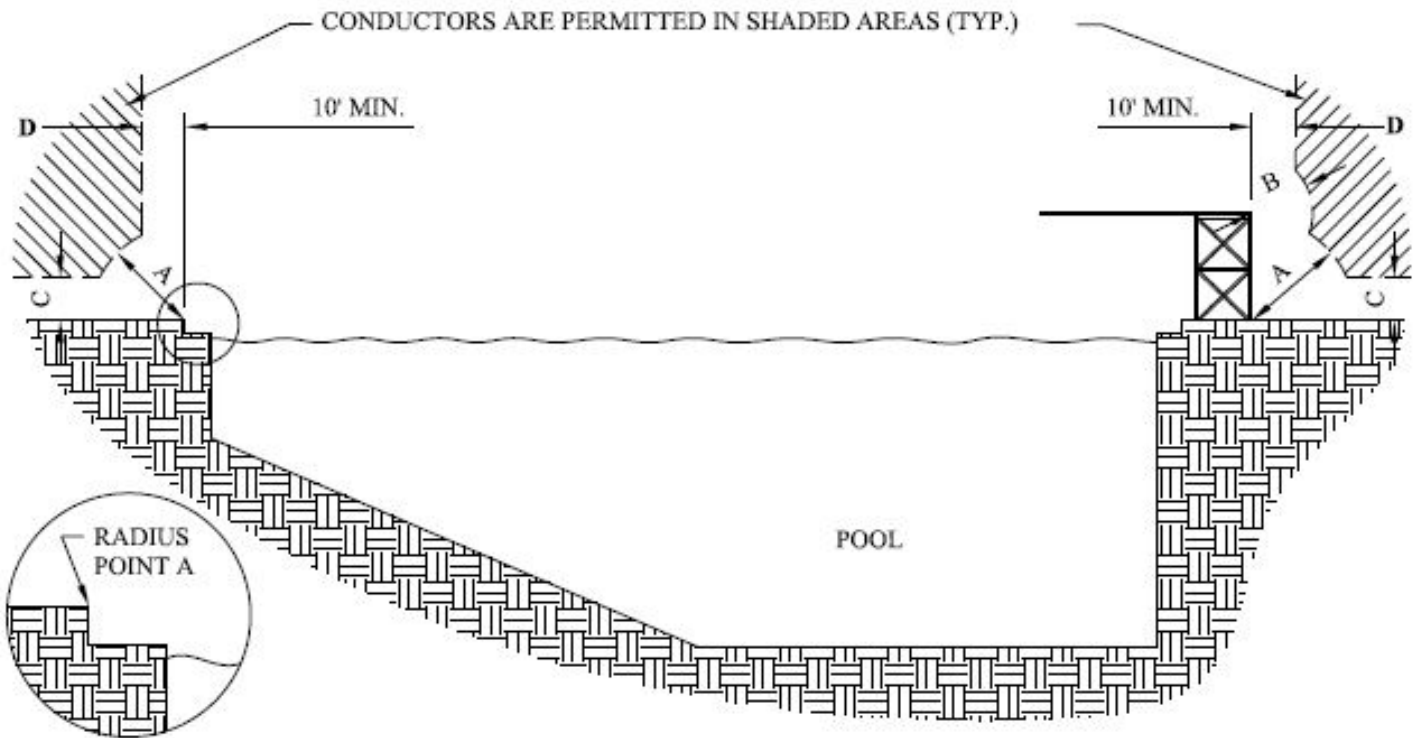

REQUIREMENT	OVERHEAD GUYS OR NEUTRAL	BUNDLED OR CABLED SECONDARY OR SERVICE	OPEN WIRE SECONDARY OR SERVICE	POLE LINE OR PRIMARY CONDUCTOR
A	22.5'	22.5'	25'	25'
B	14.5'	14.5'	17'	17'
C	AS REQUIRED BY NESC SECTION 232			
D	HORIZONTAL LIMIT CLEARANCE MEASURED FROM INSIDE POOL WALL OR OUTER EDGE OF THE DIVING BOARD OR PLATFORM.			

CLEARANCE FROM SWIMMING POOL FOOT NOTES:

- A- CLEARANCE IN ANY DIRECTION TO THE WATER LEVEL, EDGE OF WATER SURFACE, BASE OF DIVING PLATFORM, OR PERMANENTLY ANCHORED RAFT.
- B- CLEARANCE IN ANY DIRECTION TO THE OBSERVATION STAND, TOWER, OR DIVING PLATFORM.
- C. VERTICAL CLEARANCE OVER ADJACENT LAND.
- D. THIS LIMIT SHALL EXTEND TO THE OUTER EDGE OF THE STRUCTURES LISTED IN A AND B, BUT NOT LESS THAN 10 FT. OVERHEAD CONDUCTORS SHALL NOT BE PERMITTED TO PASS OVER POLES.

NOTE:

THE ABOVE CLEARANCE BALUES ARE BASED UPON THE REQUIREMENTS OF THE NATIONAL ELECTRICAL SAFETY CODE (SECTION 234) AND NATIONAL ELECTRICAL CODE (SECTION 680.8).

Figure 1.10.7B - Clearance from Water Holding Facilities to Underground Electric Facilities

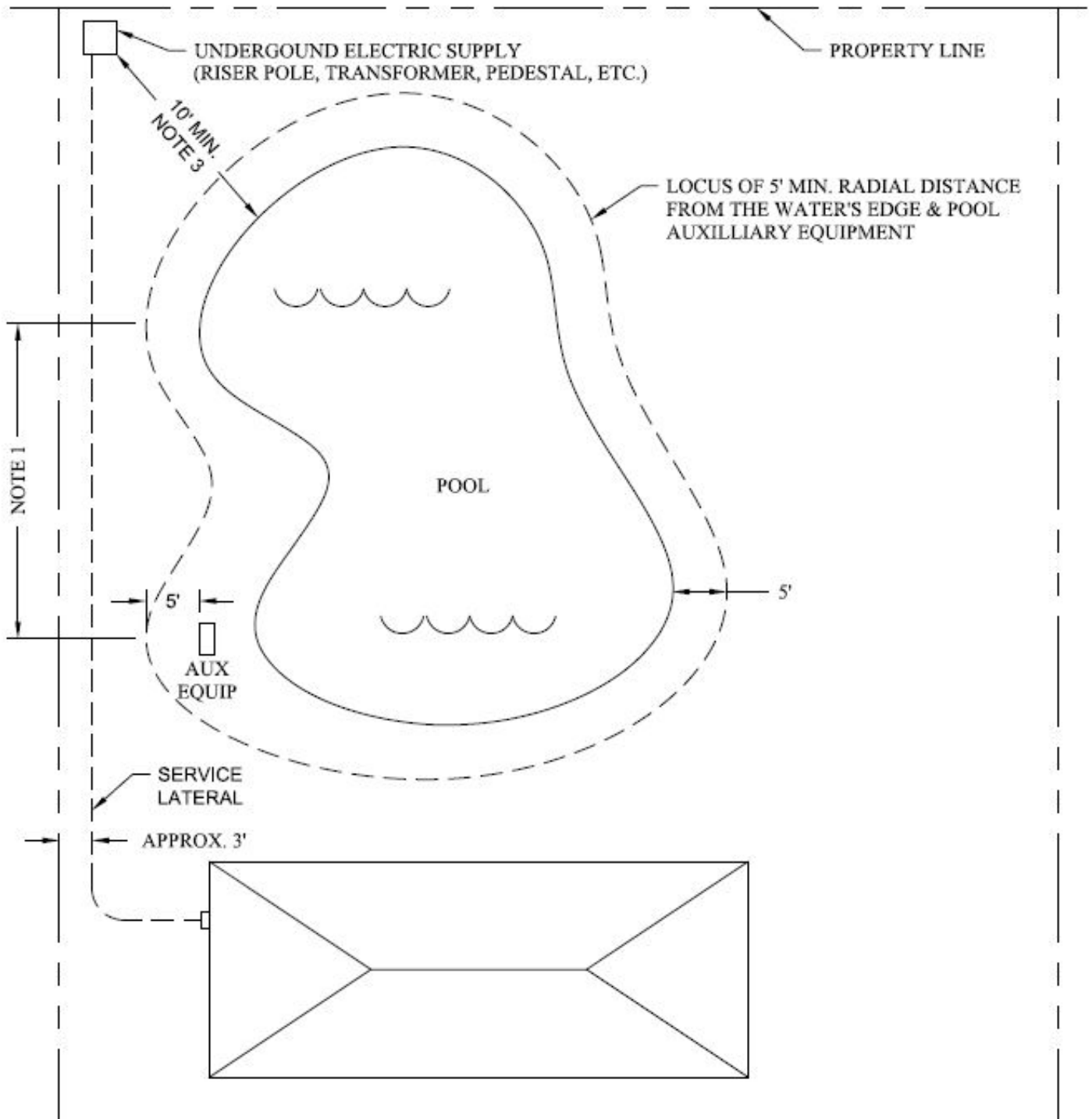

NOTES:

1. A SWIMMING POOL OR IT'S AUXILLIARY EQUIPMENT OR WATER PIPES SHALL NOT BE INSTALLED WITHIN 5' OF EXISTING BURIED CABLES OR CONDUIT FOR FUTURE A.E. FACILITIES.
2. THE SERVICE SHALL BE INSTALLED IN A CONDUIT FROM THE ELECTRIC SUPPLY POINT TO THE METER.
3. PADMOUNTED EQUIPMENT, PEDESTALS, PULL BOXES, ETC., SHALL BE LOCATED 10' OR MORE FROM THE WATERS EDGE.

1.10.8 Clearances from Septic Systems and Drain Field Systems

- A. Septic and drain field systems must be located no closer than 5 feet, measured horizontally, from service boxes, pull-boxes, transformers, secondary risers, power poles, service conduits, service conductors, and metering equipment or any other AE or Customer-owned facilities ahead of and including metering equipment.
- B. If a septic system and/or drain field system is to be installed in a residential subdivision with underground facilities, the Customer shall contact AE Design to verify underground electric locations before seeking approval from the Travis County Health department or applicable county health departments within the AE service area.

1.10.9 Clearances for Metering Equipment and Enclosures

(See Section 1.9.2)

- A. A minimum 2-inch installation clearance must be maintained on all sides of meter sockets, transockets, and meter enclosures.
- B. In addition, the minimum working clearances for metering equipment and enclosures are as follows:
 - 1. 30-inch-wide front working space with a minimum 6 inches on each side
 - 2. 36 inches in front (direction of access measured from the face of the meter socket)
 - 3. 6-foot 6-inch headroom.

1.10.10 Customer Activities in Utility Easements

1.10.10.1 Excavations

To comply with the requirements of the National Electrical Safety Code, 2007 or most current edition and this Design Criteria, it is important and necessary that all AE underground/pad-mounted facilities (or any civil work for AE facilities) be installed in anticipation of the final grade. Final grades should not be changed by excavation or filling without the prior written approval of Austin Energy. Prior to any excavation, the Customer or the Customer's engineers, designers, construction personnel, or such must contact One Call so that AE personnel can locate and mark any existing underground AE facilities. The Customer must pay in advance for the full cost of any required alteration or relocation of AE facilities to re-establish the required minimum or maximum clearances or heights.

1.10.10.2 Fences and Structures

It is permissible to install fences on utility easements provided that the fences can be removed to permit AE crew and equipment access. Fences that permanently restrict AE access to AE distribution electric lines and equipment or conflict with other utility equipment are not allowed. AE reserves the right to remove any obstruction without fault.

No permanent structures, swimming pools, or buildings are allowed on the easement. A minimum clearance of 8 feet is required around all pedestals, subsurface AE vaults or manholes that require personnel access (see also Section 1.10.4 concerning pad-mounted equipment). Prior to any digging, the Customer must contact One Call so that AE personnel can locate and mark any existing underground AE facilities prior to digging. Other detailed information concerning required clearances is contained within this section.

1.10.10.3 Landscaping and Tree Placement Guidelines

It is permissible to install landscaping in utility easements if such landscaping does not restrict AE personnel and equipment access to distribution electric lines or equipment or conflict with other utility equipment. AE reserves the right to remove any obstruction without fault.

For sodding or filling, see Section 1.10.10.1 above. For shrubbery, see sections 1.10.4, 1.10.10.2, and 1.10.10.4 for minimum clearances required around all pad-mounted equipment, pedestals, subsurface AE vaults or manholes that require personnel access.

Where the Customer installs landscaping on or trees near a utility easement (or AE facilities) such that additional upkeep, maintenance, or other costs are incurred by AE, the Customer or owner shall pay these costs. In addition, a License Agreement must be obtained from and filed with AE Public Involvement before installing any landscaping that might in any way obstruct AE's access to existing or future AE facilities located within the easement area. Contact AE Design for additional information

1.10.10.4 Trees in Proximity to Electric Utility Infrastructure

In areas where electric utility power lines or other electric utility equipment are present or proposed, only trees identified as utility compatible in Appendix F of the Environmental Criteria Manual (ECM) shall be planted within:

- A. 15 lateral feet from any overhead electric distribution conductor or equipment; and
- B. 50 lateral feet from any overhead electric transmission conductor or equipment, unless a more restrictive easement has been established.

Overhead electric utility line compatible trees, identified as "Utility Compatible (UC)" in Appendix F of the ECM, are generally those that do not reach a mature height greater than 20 feet with any exceptions identified in Appendix F of the ECM.

The following tree placement restrictions of *any* tree species apply unless approved by Austin Energy:

- i. A tree may not be placed within an electric transmission easement;
- ii. A tree may not be placed within 10 lateral feet of an electric utility pole;
- iii. A tree may not be placed within 10 lateral feet of any side of pad mounted electric equipment or within any distance between the access door and the drivable surface (i.e., street or alley) used to access the equipment (note: shrubs or other low-lying vegetation is also restricted within 10 lateral feet of the access door side and 5 lateral feet of the other sides of the pad mounted electric equipment); and
- iv. A tree may not be placed within 5 lateral feet of any underground electric equipment.

Large trees, defined as trees with a mature height of 40 feet or greater as identified in Appendix F of the ECM, may not be planted within 25 lateral feet of overhead electric conductor or equipment or within 50 lateral feet of overhead electric transmission conductor or equipment pad.

Any trees planted within 20 lateral feet of underground electric equipment must install root barriers between the tree and the equipment with a minimum installation of 4 feet deep and five feet from the equipment.

The table below provides a summary on tree planting requirements in the vicinity of electric utility infrastructure subject to approval by Austin Energy. Variations to these planting distances and tree species identified as utility compatible in Appendix F of the ECM may be made only with the explicit written approval of Austin Energy.

Type of Electric Utility Equipment	Planting Distance	Allowed Tree Types
Electric distribution conductor and equipment (overhead)	Less than 15 lateral feet	Utility compatible trees only (see Appendix F of the ECM)
	15-25 lateral feet	Utility compatible trees (see Appendix F of the ECM) and other trees identified in Appendix F of the ECM with mature height less than 40 feet
	Greater than 25 lateral feet	All
Electric transmission conductor and equipment (overhead)	Within electric transmission easement	None
	0-50 lateral feet and not within electric transmission easement	Utility compatible trees only (see Appendix F of the ECM)
	Greater than 50 lateral feet and not within electric transmission easement	All
Electric distribution and transmission conductor and equipment (underground)	0-5 lateral feet	None
	Greater than 5 lateral feet	All, when root barriers are installed
Pad mounted electric equipment (access door side)	Between access door and drivable surface (i.e., street or alley)	None
Pad mounted electric equipment (sides other than access door side)	0-10 lateral feet	None
	Greater than 10 lateral feet	All
Electric utility pole	0-10 lateral feet	None
	Greater than 10 lateral feet	Dependent on other conditions above

1.10.10.5 Digging

Prior to any digging, the Customer must contact One Call (1-800-344-8377) so that AE personnel can locate and mark any existing underground AE facilities prior to digging.

1.10.11 Clearances for Transmission and Substation Facilities

(See Section 1.14.0)

1.10.12 Clearances for District Cooling Facilities

(See Section 1.15.0)

1.10.13 Removal of Electric Utility Equipment for Demolition Permits

In accordance with City Code Section 25-11-64, an applicant for a demolition permit must submit written verification that utilities for the proposed development are suitable and sufficient for the proposed project. After a demolition application has been approved but before demolition can occur, the applicant must terminate electric utility service, unless the applicant submits a request for continued services and receives approval from Austin Energy. Otherwise, the customer must contact Austin Energy to arrange to have the

electric meter and service drop removed from the structure. Demolition may not proceed until the electric meter and service drop has been removed by Austin Energy.

The customer may contact the Austin Energy Call center at 512-494-9400 to request continuation of electric utility service or termination of service and removal of the electric meter and service drop prior to proceeding with demolition. In order to process and complete the service request for utility removals prior to demolition, the property must be vacant, the applicant must be the property owner, and the applicant must provide a valid emergency address (E911), email address, and the meter number found on the utility bill and the front of the meter. Austin Energy will provide confirmation of removal of the utilities via email and the customer should confirm completion by checking the job site and reviewing the one-time inspection demarcation found on the demolition permit. Any utility removal performed by non-Austin Energy personnel is strictly prohibited and will be assessed a tampering fee in accordance with Austin Energy's fee schedule and a hold will be placed on issuance of any permits until the fee is paid.

1.11.0 DISTRIBUTION NETWORK TRANSFORMER VAULTS

1.11.1 General Requirements for Transformer Vaults

In order to provide a high standard of electrical power to Customers served from transformer vaults, AE Network Design has formulated the following requirements. These requirements should be strictly adhered to in the planning and construction of all transformer vaults.

- A. **Codes.** The vault must conform to all requirements of the NEC, Article 450. In addition, it must conform to the other appropriate requirements for Electric Service given in this Design Criteria.
- B. **Load.** The Customer must provide an initial estimate of the total connected load and requested voltage for the proposed project as early in the planning stages as possible to AE Network Design. AE must be informed of any changes during the planning stages that would increase or change the initially estimated load. Customer shall provide an ESPA form to AE Network Design when the final voltage and load is calculated. The Customer should also provide foreseeable future expansions load information in addition to the initial load calculations. Any deviation from the original signed and approved ESPA form that would require the re-submittal of the ESPA could result in additional fee at the Customer's expense.
- C. **Location.** The location of the vault must be coordinated with AE. This location shall be at a single service address totally contained within the CUSTOMER'S BUILDING property. All services in the Network Area must comply with sections 1.5.1.3 and 1.5.1.4 of the AE Design Criteria. The vault location shall have 24/7 unabated access to the vault, including holidays. The floor of the vault must be at least 2 feet above the 100-year Reference Flood Datum (RFD) defined for that location.
- D. **Plans.** A set of plans showing the vault location, access and elevation must be submitted to AE Network Design for approval. (The Customer should allow 3 to 6 months for an AE vault design.) The Customer must provide AE with the plans of any construction changes that might affect the vault as soon as they become available. All structural plans must be sealed by a Professional Engineer registered in the State of Texas.
- E. **Secondary Strain.** The secondary phase conductors must be collected and split in a phase collection box outside the vault. Copper bus bars must be used to enter the vault

and must extend a minimum of 12 inches past the inner vault wall. A full current neutral is required. All phases shall be the same distance from the vault floor (a minimum of 8 or 9 feet depending upon the voltage and amperage); phasing rotation shall be specified by AE Network Design. All bus bars shall be vertical and shall have standard NEMA bolt spacing. No part of the stub-in may be closer than 3 feet to any wall or 1.5 feet from ceiling and shall be at a location approved by AE Network Design. AE Network Design shall approve the manufacturer's drawings of the bus duct before bus fabrication begins. (Stub-in placement and number may affect ceiling height.)

- F. **Primary Conduit.** The Customer must provide the required primary trench, conduits, manholes and pull-boxes from the vault to AE's point of service as determined by AE Network Design. No primary conduit may be routed under existing or proposed buildings or structures. The location of the primary conduit entry into the vault will be specified by AE. For details on the trench, manholes, and pull-boxes, contact the AE Network Design business unit.
- G. **Vault Agreement.** A Vault Agreement on standard COA forms, signed by the property owner allowing access for installation and maintenance of AE-installed and -owned electrical facilities and starting at the property line is required by AE. All agreement documents must be prepared by AE and mailed to the owner(s) for a signature. The completed documents must be returned to AE before AE energizes the electrical facilities on the Customer's property.
- H. **Grounding Conductor.** The Customer must provide a #4/0 bare copper grounding conductor under the floor of the vault with each end stubbed up 6 feet into the vault. The grounding conductor length will be determined by AE. The grounding conductor must be located a minimum of 6 inches below the slab and shall not be encapsulated in the concrete. The measured ground impedance shall be 25 ohms or less. In the event the above procedure is not feasible, i.e., an existing structure is being renovated, a suitable alternate grounding method shall be considered by AE.
- I. **Ventilation.** Intake and exhaust openings for AE equipment ventilation must be sized and located by AE. The Customer must provide sturdy galvanized louvers, three-hour-rated fire dampers and ½-inch galvanized mesh over the required openings. Any necessary ventilation equipment shall be provided and installed by AE. Fire damper and louver assemblies are not allowed to protrude into the vault.
- J. **Oil Reservoir.** The vault must have a concrete-lined oil reservoir, the size, and location of which will be determined by AE Network Design. The reservoir may not drain to the exterior environment.
- K. **Doors.** Vault doors must be large enough to permit transformer installation; AE Network Design shall determine their size and location. All exterior doors must be 1-1/2 hour fire-rated and must be equipped with an AE specified brand locking handles or deadbolts. All interior doors shall be 3-hour fire-rated. The Customer shall provide the locking devices and a locksmith to change the tumblers to provide access to only AE personnel. All vault doors shall be equipped with AE approved panic bars on the interior.
- L. **Truck Access.** Access to the vault shall be provided from a paved road with a minimum width of 20 feet and a minimum vertical clearance of 35 feet or as specified by AE Network Design. Where access is by a paved road or another all-weather prepared surface, the surface shall be capable of supporting, without damage to the road, a total weight of 72,180 pounds with a maximum rear axle weight of 32,530 pounds. The maximum

acceptable grade of any outside ramp leading to the vault entrance is 12 percent.

- M. **Vault Door Approach.** This 10' wide zone is the area from the vault doors to the truck access. This area is defined by 5' on each side of the center of either a double 8'x8' door or a roll up door out to the truck access area (See "Truck Access") and must maintain 35' vertical clearance. In this area there shall be no street lights, benches, trash cans, bike racks, planters, hydrants, tree wells, trees (including future canopies) or any other structure. This area may contain the Transformer/Equipment Landing Area (See "Transformer/Equipment Landing Area"). The maximum acceptable grade from the vault doors to the truck access is 12% slope and must be able to support the weight of 15,000 lbs. In some cases, AE may require a ramp to transition from the Truck Access or road to this area.
- N. **Personnel Access.** Access to all vaults must be provided by doors as described in item "Doors" above. Vaults must be locked with an AE lock and accessible only to AE personnel.
- O. **Transformer/Equipment Landing Area.** This 10' by 10' zone is an area directly in front of the vault doors needed to land transformers and equipment. This area is defined by 5' on each side of the center of any double 8' by 8' vault door or roll up vault door and 10' out from the wall surrounding the door. This 10' by 10' area shall have a smooth trowel finish and shall not contain any pavers, stamped concrete, or expansion joints. This area must be able to support the weight of 15,000 lbs. When requested, the customer shall provide a concrete steel reinforced pad outside a designated vault door within the 10' by 10' Transformer/Equipment Landing Area. This pad shall be level with the point at which it meets the finished vault floor with a 0%-2% slope away from the vault. It shall be a smooth transition from pad to finished floor with no or as small a joint as possible. AE Design shall specify pad size.
- P. **Vault Floor.** The vault floor and supporting underlying structure shall be designed to bear the weight of all transformers, network protectors and other required electrical equipment. The transformer/equipment landing area shall be an extension of the vault floor with a smooth trowel finish with no expansion joints in the floor – NO PAVERS PERMITTED. Upon receiving the preliminary electrical load calculations, AE shall provide the Customer with the required number and size of transformers. AE Network Design will provide transformer maximum weights for vault design purposes.
- Q. **Walls.** The vault room and ceiling shall be solid in construction and have a minimum of three-hour fire rating. CMU walls must be concrete filled. No wall board (sheet rock) construction is permitted on interior walls of vault. No lights, switched, electric conduit, junction boxes, ventilation, sprinklers, alarms, heat, smoke or fire sensors, etc. are permitted. Lighting installation is the responsibility of AE. The customer shall paint the inside of the vault white semi-gloss.
- R. **Vault Completion.** The Customer shall provide AE Network Design with a tentative date when any electrical power from the vault shall be required and advise AE Network Design of any changes to this date. Changes of more than 30 days shall be submitted in writing to AE. In order to meet the Customer's power date, AE Network Design shall have 6-12 weeks from the day the Customer's construction of the vault is complete to provide service. The vault shall be considered complete when all specifications and requirements of AE have been met and a final inspection by AE Network Design. AE shall not begin construction in the vault until the vault has passed final inspection. Once the vault has passed final inspection and the AE lock has been installed, the vault shall be accessible only to AE

personnel.

- S. **Inspections.** A series of vital inspections occur throughout the construction phase of the transformer vaults. A minimum of three days' notice prior to each inspection shall be given to the appropriate inspector as designated by AE Network Design. Failure to comply with any of the inspections may seriously affect vault completion and acceptance. These inspections include only those required for the vault and primary cable installation. *A detailed list of required inspections is provided in Section 1.11.4.*
- T. All inspections of the Customer's equipment and installation must be coordinated with the City of Austin DSD Building Inspections division. For inspection requests of the Customer's equipment and installation, call the automated inspection request system at 512-480-0623.
- U. Customer must contact AE Distribution Metering Operations or Inspections to request the spot location of metering equipment and other metering and meter location information.

1.11.2 Sub-surface Transformer Vault Requirements

In addition to the General requirements contained in Section 1.11.1, the requirements listed below are also required for Austin Energy to safely and reliably provide electric service from subsurface vault structures.

- A. Austin Energy service and emergency response vehicles must be provided 24-7 access to the electrical vault from a parking garage. To accommodate these vehicles, driveway lanes from garage entrance and exit to vault doors shall maintain a minimum clear height of 8 feet, 2 inches from finished floor to any structure above (i.e. beams, plumbing, conduits, signage, sprinklers, etc.). Austin Energy must be provided a dedicated and marked "Austin Energy Parking Only" parking space within 20 feet of the vault doors.
- B. For electrical vaults requiring 3 transformers to provide the requested service requirements, Customer shall provide 3-hour fire-rated masonry with minimum dimensions of 36 feet length x 30 feet width x 13 feet height. For vaults requiring 2 transformers, a 3-hour fire-rated masonry room shall be provided by the Customer with minimum dimensions of 28 feet length x 30 feet width x 13 feet height. The electrical vaults shall be designed to stop the intrusion of water through all walls, floors, ceilings, and joints. The vault room sizes listed shall be an open area without the use of columns.
- C. The vaults must be located on an exterior wall.
- D. The lift-out panels shall not be located over any part of the vault room area as stated above in Section 1.12.2 (B). The lift-out panels must be designed to Austin Energy requirements. No awning overhangs, protruding signs, decks, etc., are permitted within 35' above the lift-out panels. A 30-inch x 30-inch lid fire-rated floor door must be installed according to all applicable national standards.
- E. No vault may be more than 18 feet from finished grade at the lift out panels to the finished floor.
- F. An OSHA-approved galvanized personnel ladder extension must be installed by the Customer from the 30 inches x 30 inches lid to the electrical vault floor. The ladder is to be constructed and installed according to all applicable national standards.
- G. A minimum of an eight foot by eight foot 3-hour fire-rated door with fire-rated exit

hardware must be installed with direct access to the electrical vault from the parking garage. If fire-rated roll-up doors are requested by Austin Energy or the Customer, an additional three-foot wide by eight-foot tall 3-hour fire-rated personnel door with fire-rated exit hardware must be installed and shall provide direct access to the electrical vault from the parking garage.

- H. The Customer is to install and maintain a lighted staircase from street level to electric vault floor level in close proximity to the entrance of the electrical vault. The electrical service for the staircase must be provided from the Customer's emergency lighting panel.
- I. All Ventilation ducts must be vented to the exterior of the electrical vault. Each ventilation opening inside the electrical vault shall have 3-hour fire-rated curtain style dampers installed. The intake vents must be vented from a fresh air location (fresh air intake from the garage area is considered fresh air). The transformer vault ventilation shall not be mixed with the building ventilation systems.
- J. The Customer must coordinate in advance with Austin Energy Network Design to determine the and layout of the vault, doors, ventilation facilities, lift-out panel location, entrances, and electrical service stub-in entrance. This coordination must be during the structure design planning phase of the project.
- K. Ceiling, walls, and floor of the electrical vault must be designed to accommodate the drilling and setting of concrete anchors.
- L. The electrical vaults must be designed and constructed in accordance with all applicable NEC, NESC, City of Austin, and Austin Energy requirements.
- M. Property Owners will be required to grant the necessary easements and agreements to cover Austin Energy's operational requirements, and liability requirements
- N. Customer must contact AE Distribution Metering Operations or Inspections to request the spot location of metering equipment and other metering and meter location information.

1.11.3 Transformer Vault Construction Standards

- A. For planning purposes only, the following at-grade transformer vault construction standard drawings (plan and elevation views) are available from the AE Network Design. For more information, contact AE Network Design.
 - 1. 120/208V, up to 2,500 amp maximum demand
 - 2. 120/208V, 2,500 to 5,000 amp maximum demand
 - 3. 277/480V, up to 2,000 amp maximum demand
 - 4. 277/480V, 2,000 to 4,000 amp maximum demand
 - 5. 277/480V, 4,000 to 6,000 amp maximum demand
 - 6. 277/480v, 6,000 to 10,000 amp maximum demand
 - 7. 277/480v, 10,000 amps or above maximum demand.
- B. The Customer is responsible for contacting AE Network Design in order to work out the details for each vault. When finalized, AE Network Design will generate construction plans and send them to the Customer.

1.11.4 General Vault Inspection Requirements and Details

- A. **Inspection Requirements.** Call the Network Design business unit for the following inspections and information:

Vault Floor Ensures proper installation of a grounding conductor and oil reservoir location. The inspection must be completed prior to any backfill or concrete being placed over grounding conductor.

Primary Trench, Manholes and Pull-boxes Ensures that all requirements are met as specified by this Design Criteria and the Network Design business unit. AE Network Design must inspect all primary trenches, pull-boxes, and manhole locations and depths prior to backfilling.

Final Vault Ensures that all requirements of the National Electrical Code, National Electrical Safety Code, and AE requirements.

- B. **General Vault Details.** Vault construction details as follows are available from the AE Network Design business unit. For more information, contact AE Network Design.

1. Customer Bus Stub Into Vault (Detail #1715-010)
2. Ventilation Opening (Detail #1715-060)
3. Ventilation Fire Damper (Detail #1715-065)
4. Doors (Detail #1715-045 and 1715-030)
5. Oil Reservoir Grate (Detail #1715-)

- C. **Standard Vault Details.** For planning purposes only, the following vault construction details are available from AE Network Design. For more information, contact AE Network Design.

1.11.5 Network Area Map

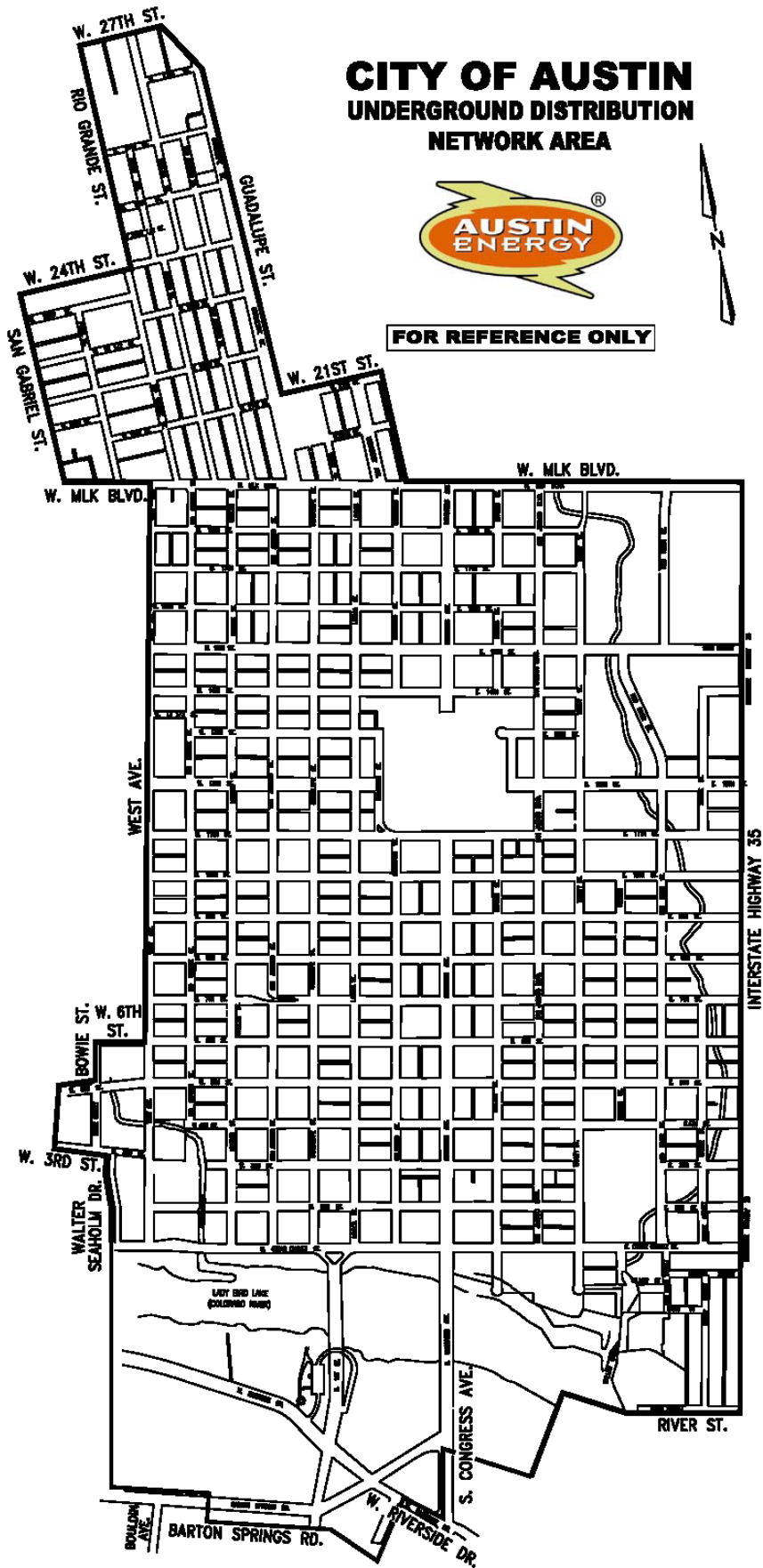

1.12.0 DISTRIBUTED GENERATION INTERCONNECTION

Section 1.12.0 provides requirements for interconnecting customer-sited electric generation assets to the Austin Energy distribution system. Additional guidance on the interconnection process for various size Distributed Generation facilities are detailed on the Austin Energy website at www.austinenergy.com. On the AE website, this guidance can be located by clicking on Contractors -> Electric Service Design and Planning -> Distribution Interconnection Guide.

1.12.1 General Requirements for Installation of Distributed Generation (DG) and Distributed Energy Resource (DER) Systems

An important differentiation for all solar PV projects is the requirement of an Austin Energy PV meter. For all residential and most commercial properties (exception: Shared Solar), the PV meter shall be installed on the customer's side of the existing billing meter. DG/DER installations that do not involve solar PV do not require a PV meter. No electrical loads shall be connected on the solar side of the PV Meter, with the exception of residential energy storage system (ESS) equipment installed with solar, equipment needed to facilitate solar production, or with written approval from Austin Energy. Where the system serves standby loads and the isolation point is in the inverter, then a 2nd PV Meter is required. All PV production must be metered prior to delivery to a load or the grid. Refer to the requirements below and to the Distribution Interconnection Guide for instances of how the PV meter will affect solar PV system installation requirements.

Homeowner exemptions are NOT allowed for interconnected solar projects.

The following equipment shall be grouped: Directory Plaque, Main Service Disconnect, Billing Meter, PV Meter, Main PV AC Disconnect, and ESS Main Disconnect (if applicable). When this is not practical, exceptions can be requested by contacting AE Solar Inspections. Ask for a meter variance form if the PV Meter must be placed in an alternate location.

1.12.1.1 Installation of Directory Plaque

A directory plaque of DG/DER disconnects and sources on site, including contact information, shall be provided as per NEC Article 705.10. Reference also Section 1.9.1.7 of this Design Criteria for formatting and attachment requirements.

- A. Where an ESS is installed, a directory plaque shall be installed by the ESS equipment if the equipment is not grouped.
- B. For utility-side interconnections, a directory plaque shall be installed at the point of interconnection, at each disconnecting means, and on the roof (by the PV array).

1.12.1.2 Installation of Overcurrent Protection

For interconnections using a step-up or step-down transformer, OCPD must be within 10 feet for both primary and secondary sides of a transformer. These cases are rare. The bonding conductor shall always match the largest neutral in the transformer.

1.12.1.3 Installation of PV Meter

An Austin Energy PV Meter is required for all new solar PV installations. AE will install a watt-hour meter. For general metering requirements, refer to Section 1.9.0. Refer also to NEC Article 110.26 for working clearances.

- A. All energy produced by the PV system must be metered before serving any loads, except for: Residential ESS equipment, loads needed to facilitate solar production, or with written approval by Austin Energy.
- B. Residential PV systems are allowed to serve standby loads where the isolation point is in the inverter, but a 2nd PV Meter is required to be placed between the inverter and the standby load panel. This is to ensure proper billing and crediting for the customer's energy consumption and PV production.
- C. Meter enclosures are to be installed with neutral broken (isolated) in PV Meter can and Main PV AC Disconnect.

- D. Meter enclosures shall be installed over flat or near level ground. Enclosures shall not be installed over points of egress for garden story window wells or recessed drainage areas.
- E. Refer to the Distribution Interconnection Guide, Section C, Figure 1 for an example of a simplified Solar PV installation. Contact AE Distribution Metering Operations for any clarification. Final determination of meter type and configuration shall be made by AE Distribution Metering Operations.
- F. If an instrument-rated (CT) meter is required, the instrument-rated CT meter inspection must be completed before the final electrical inspection is requested. Contact AE Distribution Metering Operations Dispatch (AEDMODispatch@austinenergy.com) for PV and CT inspection. To review or assess any service requirements and metering equipment needed for the project, contact AE Distribution Metering Operations (AEDistributionMetering@austinenergy.com).
- G. All solar PV interconnections require smart meters. Solar customers may not participate in smart meter opt-out.
- H. For PV installations >1MW:
 - a. The DG facility owner will need to refer to ERCOT website for more information. [Http://www.ercot.com/services/rq/re/dgresource](http://www.ercot.com/services/rq/re/dgresource)
 - b. AE shall provide the necessary EPS meter for interconnection to the AE system

1.12.1.4 Grounding and Bonding

- A. Equipment Grounding Conductors to meet #6 copper AWG minimum through the PV and ESS disconnects.
- B. Neutral must be broken (isolated) in the main PV AC disconnect and the PV Meter to allow for testing, Service rated equipment is required (no wire nuts). Exceptions can be requested by contacting AE Solar Inspections.

1.12.1.5 Installation of PV AC Disconnect

- A. A manual load break disconnect switch with visible blades shall be provided at the customer's DG service point to provide a separation point between the customer's electrical generation system and the AE electrical utility system.
- B. For solar PV systems, the main PV AC disconnect shall be installed on the solar side of the PV meter so that the meter can remain energized while the PV system is disconnected. For 480V systems, an additional disconnecting means is required between the PV Meter and the interconnection point (see diagrams B-5 and B-6 in Appendix B of the Distribution Interconnection Guide).
- C. All enclosures shall maintain 3-foot circle radius of distance from gas meters, regulators, relief valves, and electrical apparatuses, or minimum separation distance required by gas service provider.
- D. The disconnecting means shall be readily accessible to AE personnel at all times and be capable of being locked in the open position with an AE padlock and should not be locked by the owner.

1.12.1.6 Installation of Inverters

- A. Solar PV inverters must be on the approved list published by the California Energy Commission (CEC) on its website <https://www.energy.ca.gov/programs-and-topics/programs/solar-equipment-lists>.
- B. Inverters used with energy storage systems shall be listed for utility interaction.
- C. Non-solar inverters may not be installed on the solar side of the PV Meter, with the exception of ESS inverters.

1.12.1.7 Installation of ESS Disconnects

For Energy Storage Systems (ESS), at least one lockable, visible blade DC disconnect is required for first responders on external DC conductors between the battery and the inverter (not required for self-contained systems). Additional disconnects may be required in accordance with NEC 706.15. ESS disconnects are required to be installed within 5 feet of the main panel. Check with the local Fire

Department for additional requirements. A. Additional labelling required for ESS Main Disconnect and Main Service Panel: WARNING ENERGY STORAGE SYSTEM ON SITE: ESS DISCONNECT AND MAIN BREAKER IN MAIN SERVICE PANEL MUST BE OFF FOR WHOLE HOME ELECTRIC SHUTOFF. B. For inverter-integrated ESS, a lockable, visible blade AC disconnect is required for first responders on self-contained systems when used in a backup application. Additional disconnects may be required in accordance with NEC 706.15. ESS disconnects are required to be installed within 5 feet of the main panel and in sight of the battery, and before the backup panel.

1.12.1.8 Installation of Raceways

- A. PV communication wire is not permitted inside metering equipment.
- B. Solar conductors (both AC and DC) run internal to a structure are required to be in metallic cable or raceway, and must be labeled every 10 feet.
- C. For utility-side interconnections, all conduit containing PV output conductors must be labeled "Line Side". This label shall be affixed to the PV circuits, and written in permanent paint inside the CT enclosure, if applicable.

1.12.1.9 Installation of Energy Storage Systems

- A. ESS plans shall be sealed by a Professional Engineer licensed in the state of Texas.
- B. Where an ESS provides partial home backup, a label shall be affixed to the main panel that reads: THIS ENCLOSURE CONTAINS FEED THROUGH CONDUCTORS THAT MAY BE ENERGIZED WHEN THE DISCONNECT IS DE-ENERGIZED.
- C. PV system shall be operational at the time of inspection and be able to demonstrate full functionality.
- D. Where ESS are installed in garages (on sidewalls or front wall), one or more bollards must be installed to prevent vehicles from making contact with each ESS unit.
- E. Installation of ESS inside a dwelling unit is not allowed.

1.12.1.10 Installation of Solar PV Array

- A. Plans must be sealed by a Professional Engineer licensed in the state of Texas when: Modules are not mounted parallel to the roof surface (e.g., tilt-up), extend past the existing roof, are built on a new and separate structure (e.g., ground-mount), are installed on a commercial building, or where solar roof tiles are being installed. If the customer is located inside City of Austin Full- or Limited-Purpose jurisdiction, a building permit shall also be required in these scenarios. Please see Distribution Interconnection Guide for additional detail.
- B. All roof penetrations must be flashed.

Where a PV aggregate panel is installed, a label shall be affixed to the panel that reads: PV AGGREGATE PANEL: DO NOT ADD NON-SOLAR LOADS.

1.12.2 Utility-Side Solar Interconnections

This is where the DG/DER system is electrically connected directly to the Austin Energy System, i.e. on the line side (ahead) of the revenue meter. Utility-side interconnected systems (not on the Downtown Network) of ALL sizes must:

- A. The point of interconnection for the solar conductors shall be one of the following: a. At the transformer serving the site. For sites that are master metered at the transformer, a new transformer may be built ahead of the existing one in order to establish the utility-side interconnection, but will require a written exception from Austin Energy. b. At a service distribution enclosure located between the billing meter and transformer. A new service distribution enclosure may be built for this purpose. c. In the modular metering bank (for facilities that have one), on the line side of the main disconnect.
- B. If the point of interconnection is the transformer: a. For pad-mounted: The solar conductors shall be terminated at the point of service. b. For pole-mounted: Where the point of service is a weatherhead, the contractor shall be responsible to construct a new riser for the solar conductors. The contractor will be responsible to install a separate weatherhead for these conductors, and AE will connect it to the existing weatherhead to make the final interconnection. Where the point of service is a pull box fed from a secondary riser, the solar conductors shall be brought into the pull

box to make the final interconnection.

- C. If the point of interconnection is a service distribution enclosure: a. Enclosures must be solid and lockable with a full-size barrel lock, to be provided by Austin Energy. AE will lock the enclosure with an AE-supplied lock after the final inspection passes. b. Enclosures shall conform to the specifications listed in the Section 1.8.5. c. The customer will own this equipment and will be responsible for installing and maintaining it. d. If the customer requires access to the enclosure after it is locked, they must contact AE Revenue Protection.
- D. Where installing a distributed generation (DG) system that will interconnect ahead of the AE meter, submit an approved Distributed Generation Planning Application (DGPA) with the ESPA (see section 1.4.0 for ESPA submittal). If the DG system subsequently changes, a new DGPA and new ESPA must be submitted.
- E. Where customer-installed underground work includes conduit for interconnection of a solar system, AE Solar Inspections must also perform an inspection in addition to and in coordination with AE's civil and electrical inspections.

1.12.3 Interconnection of DG/DER Systems on the Downtown Network

A secondary-connected customer must not back feed to the downtown network grid. Customers that cause the network protector to trip open due to back feed shall provide a solution to mitigate any future unintentional trips caused by customer back feed.

1.12.4 Permission to Operate

The customer SHALL NOT have permission to operate electrical generating equipment in parallel with the AE electrical system until the installation has passed all inspections, with the exception of on-site system testing required to ensure readiness for inspection. For solar PV systems that do not already have a PV meter, AE Distribution Metering will conduct a site visit to install this meter after the final inspection has passed. The customer has permission to operate the system once the meter is installed.

1.13.0 SMALL CELL INTERCONNECTION

Procedures and guidelines for the provision of Austin Energy electric service to Small Cell installations shall be in accordance with Austin Energy Design Criteria and specific requirements as determined by AE Design. Section 6 of the Utilities Criteria Manual (Austin Energy Pole Attachments) implements City Code Chapter 15-7 pertaining to the use of Austin Energy distribution and street lighting infrastructure by providers of cable television, telecommunication, and certain other data or communication services, including wireless service who possess the right by virtue of city, state, or federal law to access and operate on electric utility infrastructure. Contact the Pole Attachment Services business unit for more information.

1.14.0 TRANSMISSION AND SUBSTATION REQUIREMENTS

This subsection documents the requirements for development that occurs within 100 feet of Austin Energy's transmission and substation assets. The requirements of this section are not applicable to Distribution facilities, which are detailed in other sections of this document.

1.14.1 Introduction

1.14.1.1 Transmission and Substations

Transmission lines and Substations are components of the electric power delivery system. Simply put, they are the link between generation (power plants) and distribution (your electric service). This is illustrated in the diagram below:



Transmission lines and distribution lines have a similar function and can look somewhat similar. The main difference between transmission and distribution is the voltage – at AE most distribution facilities operate at 12,500V (Volts), while transmission operates at 69,000V, 138,000V, or 345,000V. Transmission lines use a higher voltage to carry power greater distances with less power loss. The higher voltage means that transmission assets are generally larger – poles are taller and wider, and the wires are spread further apart. Refer to the following images and the Wire Guide below for guidance on which lines are distribution, transmission, and third-party facilities.

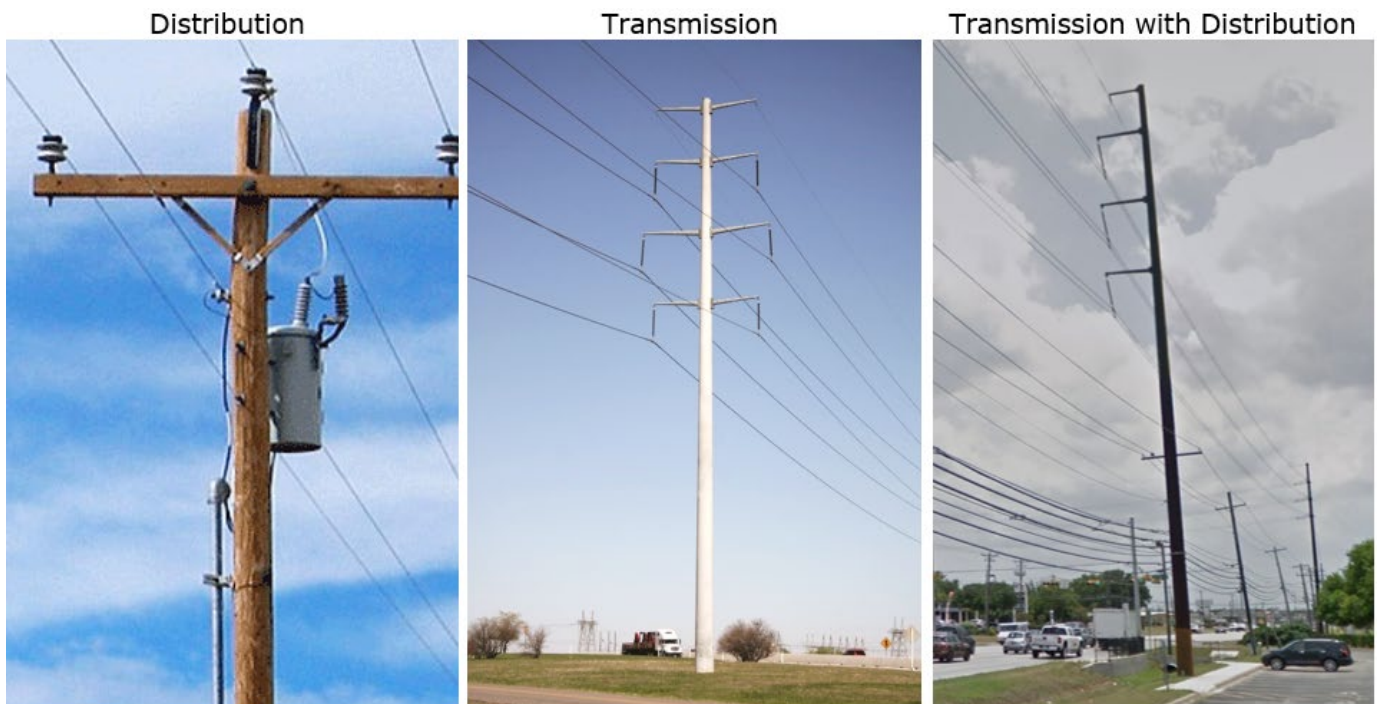

WIRE GUIDE

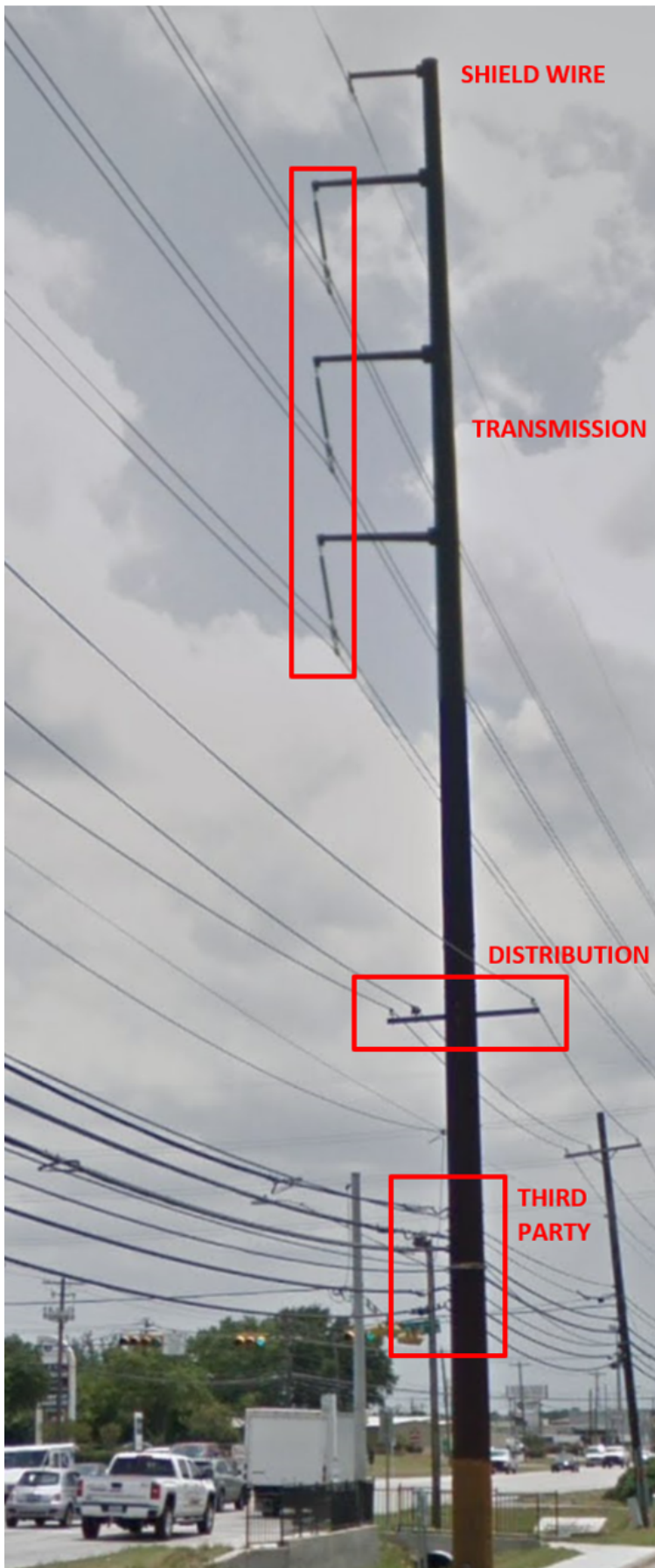

A **Shield wire** is located at the top of the structure to provide lightning protection on transmission lines. Distribution lines do not have shield wires.

Transmission lines are 3-phase lines, and have longer insulators, depending on the voltage, with the minimum length being about 3'. Insulators are the non-conductive hardware connecting the energized wires to the grounded structure. There are a variety of different types of insulators. Transmission lines are typically located more than 60' above the ground when distribution lines are located below, but may be as low as 30' above the ground when there is no distribution present underneath.

Distribution lines are also 3 phase lines, with a separate neutral, typically located below the other wires. As can be seen here, it is common to have multiple distribution structures, located within a single transmission span. Distribution insulators are between 3 and 6 inches long. These attachments are typically between 30 and 40' above the ground.

Third party attachments are a safe distance below distribution. Austin Energy is required to grant access to our structures to third party providers (telecom, cable tv, etc.). These facilities are not energized, but must still provide sufficient overhead clearance for vehicles. These attachments are typically between 18 and 25' above the ground

1.14.1.2 Why are There Different Requirements for Transmission?

Austin Energy, like most utilities, has different requirements for transmission lines than it does for distribution lines. The main reason for the different requirements is that transmission lines operate at a higher voltage and require greater clearances for safety and reliability. Economical transmission lines typically have much taller structures and longer spans than distribution, which means that the wires can move due to wind, weather conditions, and current in the wires. This wire movement must be accounted for in determining the required transmission line clearances, whereas there is minimal wire movement on distribution circuits. See diagram to the right, showing deflected wire positions.

The longer span lengths in transmission lines also result in much larger variations in the wire sag. "Sag" is the drop in the wire between two supporting structures. Sag varies over time, and even throughout the day, depending on the ambient weather conditions, and the heat generated from the current in the wire. The sag one observes on a transmission line is most likely not the maximum sag that the line is designed for, which may be caused by ice accumulation on the wires, or the wire operating at its maximum capacity and temperature. Clearance calculations must take into account the maximum sag conditions on the line to ensure safe clearances under all possible operating conditions.

Since transmission lines serve as a main arterial for power flows, unanticipated outages on a transmission line can affect a large number of people and are difficult to restore in a timely manner. By contrast, distribution circuit outages affect a much smaller number of customers and can typically be restored much faster.

Due to the critical nature of transmission lines, unimpeded access to the lines must be maintained in order to allow AE to make emergency repairs as quickly as possible. The equipment needed to perform work on transmission lines can also be

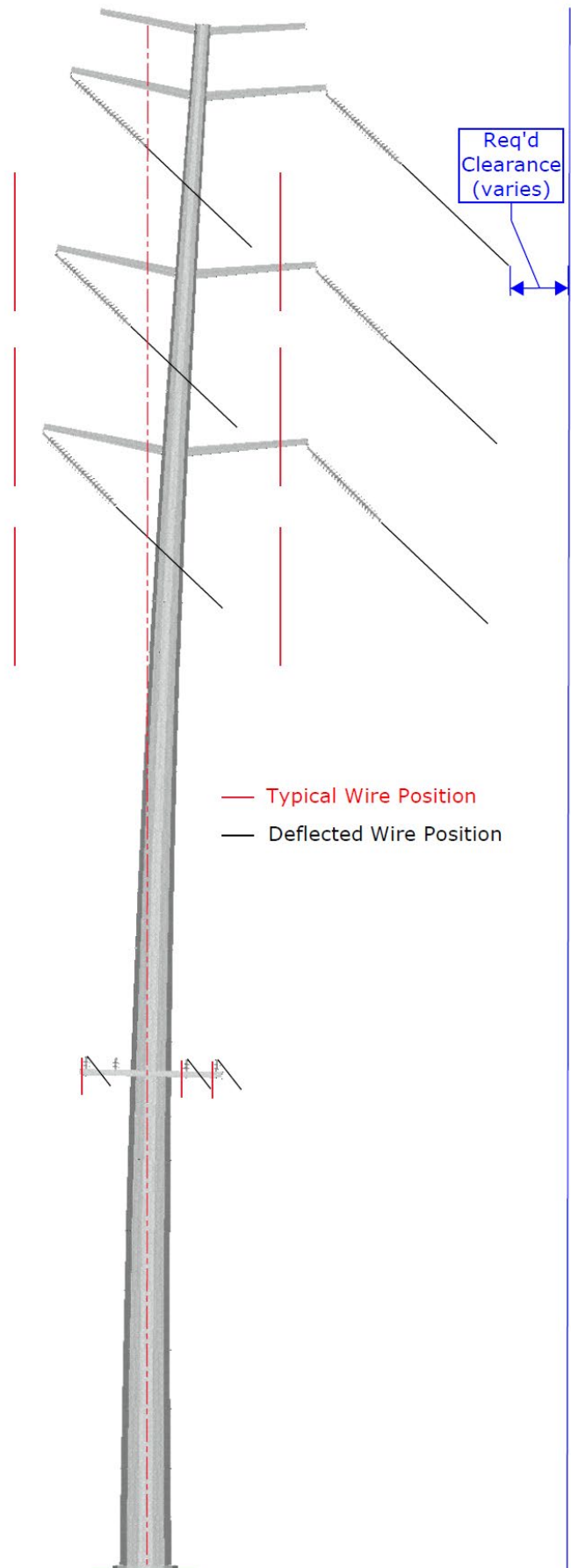

much larger and heavier than what is needed for distribution lines.

Requirements for development in the vicinity of distribution lines are covered in other sections of this document. Development in the vicinity of distribution is very common, as nearly all properties require distribution lines to deliver power. Development near transmission lines is much less common as they only connect generation to substation, or substation to substation. Austin Energy currently owns and operates nearly 12,000 miles of distribution lines, and by contrast, just over 600 miles of transmission lines. Even though they are less common, some properties are still affected by transmission lines.

1.14.1.3 Properties Affected by Transmission Lines

Generally speaking, if a transmission line or a transmission easement is not located on a property, the property is most likely not affected by transmission lines. If a proposed development is not within 100 feet of the nearest transmission line wire, it will not be affected. If a proposed development is within 100 feet of the nearest transmission line wire, then Austin Energy's engineering staff must evaluate and determine the required clearances, accounting for structure deflection, wire blowout, and insulator swing. Austin Energy also evaluates proposed development in regard to access, vegetation, and its potential effect on the integrity of the structures and AE's ability to maintain and operate the transmission line.

1.14.1.4 Substation Requirements

Electrical substations are typically constructed on parcels owned by Austin Energy, and as such, do not typically create limitations for development on adjacent properties. There are some exceptions, as discussed below. Substations often have multiple transmission and distribution lines entering/exiting them. The requirements for those facilities must also be met, as detailed in other sections of this document

Required safety clearances must be maintained to energized facilities within the substation. Substations are typically constructed in such a way that no additional electrical clearances are required beyond the property line. However, this isn't always the case, therefore Austin Energy needs to review any proposed land development that abuts an AE Substation. Of particular concern are trees or other vegetation planted near the property line that can grow over the property line, or tall buildings constructed adjacent to the substation property line.

Site drainage must not negatively impact the substation property, either by draining onto the substation site or by preventing natural drainage away from the substation site.

Excavation near a substation that could cause a structural or stability issue for the substation should be limited. Any proposed excavation greater than 1 foot in depth, within 25 feet of the substation property line must be reviewed and approved by Austin Energy. Large vehicles and heavy equipment often move throughout the substation, and any wall, excavation, or subsurface installation must be designed to support these heavy loads.

Fences must be electrically isolated from substation fences. If a fence needs to connect to a substation fence, a 10-foot, non-conductive isolation panel must be installed between the two fences.

Austin Energy must maintain 24-hour access to the substation. Access for large vehicles and large equipment is required. Any proposed development that would limit access to the substation is not permitted. Where required, Austin Energy may obtain an access easement to ensure access to the substation is maintained.

Property owners will be responsible for any outages or damage at Austin Energy substations caused by the development. This includes but is not limited to damage or outages caused by

excavation, or from conductive objects that may fall or blow into the substation.

1.14.1.5 Transmission Lines Owned by Other Entities

Not all transmission lines located in the Austin area are owned by Austin Energy. Other utilities, such as the Lower Colorado River Authority, have transmission facilities in the Austin area. If your property is affected by another utility's transmission or distribution lines, you will need to coordinate with them to determine what is acceptable, as their requirements may be different than Austin Energy's.

1.14.1.6 Transmission Interconnection Requirements

The requirements for third parties to interconnect with the Austin Energy transmission system are provided in the Austin Energy Facility Connection Requirements document, which is available on Austin Energy's website. Go to www.austinenergy.com and search for "facility connection requirements".

1.14.2 Transmission Review

Upon request, Austin Energy can review subdivision/site plan packages to provide feedback on the necessary requirements for easements, clearance, access, and other potential issues prior to formal submission through the land development application process.

Austin Energy can provide the necessary clearances required from its transmission facilities, accounting for structure and wire movement for the variety of required loading conditions, using Austin Energy's engineering software, LiDAR survey data, and computer models of the line. Austin Energy has performed aerial LiDAR surveys on all of its transmission assets. This provides accurate survey data showing where Austin Energy structures and wires are located. However, it does not provide information on property boundaries. Unless a survey is provided that shows the property boundaries in relation to the location of the transmission infrastructure, it can be difficult to provide accurate clearance information from the property boundaries. When no property boundary information is available, AE will typically use Travis County Central Appraisal District (TCAD) parcel boundaries and may have to include an additional buffer to account for inaccuracies in the TCAD data. To receive the most accurate and least restrictive determination, the developer should provide a survey of the parcel showing the transmission line, including structure and wire locations. Preferably, this data can be provided electronically in native format, so it can be merged into the transmission line model for the quickest and most accurate determination of the required clearances.

Subdivisions and site plans will also be reviewed in terms of their effect on access and compliance with Austin Energy landscaping requirements to ensure the proposed development will not cause harm to transmission infrastructure or other potential issues.

It is important for a developer to obtain this information early in the site development process, so that no time is wasted designing improvements that may not be permitted.

1.14.2.1 CAD File Requirements

Surveys or plans for proposed development (site plan, grading plan, landscape plan, etc.) shall be provided in georeferenced AutoCAD or Drawing Exchange Format (DXF) files. Georeferenced electronic files must use the State Plane Coordinate System (NAD83, Texas Central 4203, US Survey Feet). Files must be in the World Coordinate System (WCS) and only include base files, no xrefs should be attached. AutoCAD files must be in Version 2019 or earlier.

Provided surveys and site plans must show all existing easements and property boundaries, and any existing Austin Energy facilities (structures, guys, conductors, etc.).

1.14.3 Safety Clearances

1.14.3.1 Permanent Clearance Requirements

Clearance is the air gap required between the energized wire, in its deflected position, and another object. The minimum allowable clearance values can be found in Section 23 of the NESC. Clearance requirements are a function of, among other things, the voltage of the line. Higher voltages require higher clearance values. Austin Energy includes small adders on top of the NESC clearance values, in order to provide a buffer to allow some survey and construction tolerances. The buffers used are based on guidance from the "Design Manual for High Voltage Transmission Lines" published by Rural Utilities Service of the US Department of Agricultural, RUS Bulletin 1724E-200. Given the risk involved, and the number of variables affecting the clearance, including these additional buffers is prudent to ensure the safety of the general public and Austin Energy staff. Additional checks as recommended in the RUS bulletin are also done to ensure safety under all potential operating conditions.

The required clearance values vary depending on the nature of the object to which the clearance is being checked. The required clearance envelope for a transmission line is a complicated, site-specific, three-dimensional shape that cannot be easily published in a simple table or diagram. When clearance values are needed, a developer should contact Austin Energy as soon as practical so that AE can evaluate the specific location and provide the required clearance(s).

Proposed grade changes underneath the line may negatively impact the vertical clearance and may be restricted. If a grade change is made that results in the line (transmission, distribution, or third-party attachments) not having adequate vertical clearance, the owner/developer is responsible for any costs for the work required to address this issue, including but not limited to replacing the supporting structures with taller structures.

1.14.3.2 Working Clearance

Strict compliance with Texas laws and OSHA rules is mandatory. Refer to the Texas Health & Safety Code, Chapter 752 and the following paragraphs for more information.

OSHA publishes rules that govern how closely workers and their equipment can get to energized electrical equipment, including power lines. Individuals working in the vicinity of energized electrical equipment must ensure that their work complies with the OSHA regulations.

The following list provides some of the most commonly-applicable OSHA Rules:

[OSHA 29 CFR 1910.333\(c\) – Working on or near exposed energized parts](#)

[OSHA 29 CFR 1926.416\(a\) – Protection of Employees](#)

[OSHA 29 CFR 1926.1400 – Cranes and Derricks in Construction](#)

[OSHA 29 CFR 1926.451\(f\)\(6\) – Clearance between scaffolds and power lines](#)

For easy reference, the following summation of the OSHA Regulations are provided:

1910.333(c)(3)(i) unqualified persons and conductive objects (tools) and 1926.451(f)(6) scaffolds shall maintain the following clearances:

Voltage, Nominal (kV)	Required Clearance (ft)
12.5	10
69	10
138	11.33
345	15.33

1926.1400 – Cranes and Derricks (Option 2) – Make sure that no part of the equipment, load line, or load (including rigging and lifting accessories), gets closer than 20 feet to the power line, by implementing measures specified in OSHA 129.1400(b)

OSHA references the possibility of having a power line de-energized in order to perform work in the vicinity of a line. This may be possible for a distribution circuit, but due to the critical nature of transmission lines, Austin Energy is not able to take a transmission circuit out of operation to accommodate land development near a transmission line.

1.14.3.3 Transmission Lines with Distribution Underbuild

Depending on the configuration of the lines and where they are located relative to the property or proposed development, the required clearances may be controlled by the underbuilt distribution line, rather than the transmission line. For lines that have both distribution and transmission, the requirements of both types of lines must be met. Distribution clearance requirements are detailed in Section 1.10 of this document.

1.14.4 Access

AE must maintain 24-hour, unimpeded access to its transmission lines in order to respond quickly to an unscheduled outage. Large equipment such as cranes, bucket trucks, and drill rigs are needed to maintain and make necessary repairs to transmission facilities. In order to accommodate access for these vehicles, and prevent damage to the property, the following accommodations must be made.

- A. Access Corridor – 25 feet wide, level access corridor all along the length of the ROW, with 16 foot minimum vertical clearances. Facilities paralleling a public roadway can generally use the public roadway to achieve this access.
- B. Working Area Around Structures – No above ground obstructions within 100 feet from the edge of a transmission structure, unless otherwise approved by Austin Energy.
- C. Gates – Fences (temporary or permanent) that cross the ROW must provide a gate to allow 24-hour access by AE equipment and personnel. The gate must be a minimum of 16 feet wide. Depending on the angle between the fence and the ROW, a 32-foot gate may be required. The gate must have an AE lock, and can accommodate multiple locks in series if the property owner needs to maintain access through the gate. Gates in proximity to structures need to be offset far enough to allow through access for AE vehicles.
- D. Grade – the property owner is not required to grade the property to accommodate AE access, unless grade changes in the ROW are going to be made. If so, no slopes greater than 8% (4.6 degrees) will be allowed. Grade changes in the ROW are subject to other requirements as well to ensure that structures are not compromised, and that clearance requirements are maintained.

- E. Curbs – Curbing installed in the ROW must be lay-down curbs in order to ensure that access for AE equipment is not impeded. Austin Energy will not be responsible for damage to curbing placed in the easement.
- F. Vehicle Weight – Anything installed in the ROW (pavement, bridges, subsurface infrastructure, walls, etc.) must be designed to support a 46,000 lb tandem axle (5-foot spacing). Austin Energy will not be responsible for damage done to facilities placed in the easement or to facilities placed outside the easement (such as walls) that are damaged a result of AE equipment traversing the easement.
- G. Drainage Areas/Detention Ponds – Drainage areas and detention ponds are not allowed in the transmission ROW since they can restrict access along the length of the ROW.
- H. Off-ROW Access – Some existing easements include rights to access the easement from other parts of the property. When an existing easement does not include these rights, but either existing or proposed developments prohibit access to or along the easement, an additional off-ROW access easement may be required. Off-ROW access corridors are subject to all of the same requirements as on-ROW access corridors.
- I. Prohibited Crossing Areas – some areas of the ROW may already prevent continuous access along the ROW. This may be due to natural (creeks, cliffs, drainage areas, etc.) or man-made features (drainage, walls, etc.). When such an obstruction is present, a turn-around area or other off-ROW access may be necessary. Due to the large turning radius of some of the equipment used, turn-around areas can be quite large. These issues are very site-specific and need to be addressed on a case-by-case basis.

1.14.5 Structural Integrity

1.14.5.1 Structural Design Standards

The structural design of transmission structures is also covered in the NESC in sections 25 and 26. Other documents such as the RUS manual (Bulletin 1724E-200), and the American Society of Civil Engineers (ASCE) Manual of Practice 74, "Guidelines for Electrical Transmission Line Structural Loading" provide guidance for additional load cases and best practices. There are a variety of other design manuals and standards that are also used in the structural design of transmission structures and foundations. Austin Energy needs to ensure that its transmission structures remain in compliance with the NESC and other industry standards and are not compromised while in service.

1.14.5.2 Excavations and Drainage

In order to preserve the integrity of the foundations for AE's structures, AE generally limits excavation and grading in the vicinity of transmission structures, including guys and guy anchors. As a rule of thumb, excavations that are more than 25 feet from the edge of a transmission foundation, will generally not cause an issue. Excavations within 25 feet of a transmission foundation that are more than 1-foot deep, need to be evaluated by AE. A number of factors, including the depth and width of the excavation, the duration it will be open, whether it is a permanent or temporary grade change, the distance from the foundation, and the orientation relative to the loads on the foundation, can affect whether or not a proposed excavation would be detrimental to the transmission structure foundation. Also, changes in grade that will negatively impact the drainage in the vicinity of the structure and potentially lead to corrosion issues at the base of the structure will not be allowed.

1.14.5.3 Protection for Vehicular Traffic

To provide for the safety of the traveling public and to protect Austin Energy transmission assets from

damage, a minimum distance of 5 feet must be maintained from the face of curb to the face of structure for typical low speed roadways. If this distance cannot be maintained, collision protection devices may be required, if approved by Austin Energy. Distances larger than 5 feet may be required on high speed roads (highways and main arterial roadways). The installation and cost of any required collision protection devices will be the responsibility of the property owner.

1.14.5.4 Environmental Contamination

Various contaminants, including water, chemicals, paint and dust, can cause issues on a transmission facility. Issues such as corrosion of the steel supporting structure, or flashovers caused by excess dust on the insulators or in the air between the phases of the line can be problematic. For these reasons, some developments that may result in an excess application of these contaminants may be restricted. It is also the responsibility of the property owner and contractor to control dust in order to minimize contamination of wire and insulators during construction. Any subsequent cleaning or electrical outages caused by dust from a construction project will be charged to the property owner and contractor.

1.14.6 Vegetation

Vegetation near electric facilities presents operational and fire risks and can impede access to maintain and inspect the facilities. Austin Energy typically performs vegetation clearing on a five-year cycle. When vegetation is removed, enough is removed to ensure safe operation of the line for the next five years. Austin Energy trims vegetation to ensure sufficient clearance from energized facilities but may also trim vegetation that impedes access, including along off-ROW access corridors.

For proposed developments, no trees may be planted in a transmission easement. Outside of the easement, any trees planted within 50 feet of an existing or proposed transmission facility (structure, guy, conductor, etc.), must be a utility-compatible tree. A list of utility-compatible trees can be found in Appendix F of the Environmental Criteria Manual.

Any vegetation planted within a transmission easement is at risk for damage during AE's inspection and maintenance of the line. Shrubbery must not obstruct access to the base of the transmission structures. Climbing vegetation on electric facilities is prohibited. Austin Energy is not responsible for damage to vegetation planted within the easement.

Compost and mulch are prohibited above the concrete foundation of transmission structures, including guy anchors.

No water sprinklers are allowed within 25 feet of a transmission structure, including guy wires and guy anchors.

1.14.7 Easements for Transmission Facilities

Austin Energy obtains easements to ensure that it has the property rights necessary for the safe construction, operation, maintenance and access to its transmission facilities and to ensure that necessary transmission facility clearances are maintained. These easements cover the physical location of the transmission facilities, the area needed to access its facilities, areas needed for construction, operation and maintenance of AE's facilities, and areas that, if developed, would violate required electrical clearances or interfere with access to AE facilities. If transmission easements that were obtained in the past are not adequate to provide these protections, then AE works to expand existing easements or obtain additional easements.

Transmission easements include metes and bounds descriptions of the areas subject to easement rights, and AE's easements do not typically include rights to the remainder of the property (blanket, ingress or egress rights). If off-ROW access to transmission facilities is needed, then AE will typically

acquire separate access easements. If access to property is needed for temporary use during the construction or reconstruction of a transmission facility, then AE may acquire a temporary construction easement, rather than a permanent easement.

When a property is subdivided, AE shall require a new or expanded easement to cover: 1) an existing transmission facility in an existing easement that is inadequate to meet current AE easement requirements; 2) a planned new transmission facility; or 3) space required by planned upgrade to an existing facility.

Any additional easements proposed to be co-located within a transmission easement, either crossing or paralleling, must be reviewed and approved by Austin Energy in advance (including trail easements).

While land located within a transmission easement may be labeled as greenspace or open space, it cannot be labeled or dedicated as parkland.

An owner or developer may not place, erect, construct or maintain the following within an electric transmission easement:

- A. any permanent structures including, but not limited to, habitable structures such as homes, mobile homes, garages, or offices,
- B. any structure of any kind in such proximity to the electric transmission or distribution lines, poles, structures, towers, or appurtenant facilities that would result in a violation of the required clearances in effect at the time the structure is erected, nor
- C. any structures including, but not limited to, fences, storage sheds, drainage, filtration or detention ponds which would impair Austin Energy's access to the transmission easements or its lines, poles, structures, towers or appurtenant facilities in the easements.
- D. fire hydrants cannot be located inside the transmission easement and must be a minimum of 20 feet from any transmission structure.
- E. septic Systems and drain field systems are not allowed in electric transmission and substation easements.

1.14.8 Grounding

High voltage lines create an electric field that can induce a voltage in ungrounded metallic objects, including buildings, large vehicles and equipment, and fences. This is referred to as induction. The amount of voltage that builds up is a function of the length of the object paralleling the line and is most commonly observed on long metallic fences that parallel a transmission line. Longer fences can be broken up into smaller sections by installing non-conductive isolation panels at various intervals along the length of the fence. Proper grounding of metallic objects in the ROW is important to mitigate this issue.

AE discourages placing metallic fences in transmission line ROW. If it is necessary to use a metallic fence, or if there is an existing metallic fence, many of the potential issues can be mitigated through proper grounding of the fence, and proper placement of isolation panels. Austin Energy does not provide guidance, or recommendations for what grounding needs to be provided on a landowner's metallic fence. AE recommends against the not to use of a metallic fence in or near transmission line ROW. If you do use a metallic fence, it should be made sure that it is properly grounded. Austin Energy does not provide guidance, or recommendations for what grounding needs to be provided on a landowner's metallic fence. In order to determine what constitutes "proper grounding", you may need to consult an electrical engineer to do a grounding study, accounting for the specific site conditions including local soil resistivity.

Metallic fences that are roughly perpendicular to a transmission line, generally do not pose issues with induction, but they can present issues in the case of a dropped conductor or a lightning strike, particularly if they are near a structure. While it is not a common occurrence, an equipment failure can result in an energized conductor dropping to the ground. If an energized conductor drops on a metallic fence, it can energize the fence and carry the electricity a great distance, causing potentially negative impacts far away from the fallen conductor. Proper grounding of metallic objects in the ROW is important to mitigate this issue.

Because the height of the poles, it is fairly common for transmission structures to be struck by lightning. Transmission structures are grounded in order to carry the impacts of lightning strikes or other line faults to the ground. The impact is quickly dissipated through the earth over a short distance from the pole, limiting the area of exposure. However, if there is a metallic fence in the vicinity of the pole, the stray voltage from the lightning strike or line fault can travel through the fence and have impacts a long way from the transmission structure. Proper grounding of metallic objects near transmission structures is important to mitigate this issue.

1.14.9 Construction Requirements

A pre-construction safety meeting between Austin Energy and the construction contractor is required 48 hours before commencement of construction. If cranes or scaffolding will be used on the project, Austin Energy must be notified so the appropriate AE staff can attend the pre-construction safety meeting.

Construction crews must comply with OSHA requirements to maintain safe clearances for workers and equipment in the vicinity of energized power lines. Austin Energy can provide the voltage of its facilities and can determine the required OSHA clearances. Do not assume the voltage of the line. If you are unsure, contact Austin Energy for clarification. Transmission lines cannot be de-energized for the purpose of nearby construction, even on a temporary basis. See Section 1.14.3.2 for more information.

Barricades must be erected 10 feet from any transmission structures (including guys and anchors) within the area of construction. Warning signs must be placed under any overhead electric facilities to notify of the overhead electrical hazard.

Do not store construction materials or place spoils within the transmission easement. Throughout the duration of construction, Austin Energy must maintain 24-hour access to and along the easement. If a security gate is placed around the project that encompasses the site, Austin Energy will need to have a lock that they can use to access the site.

Austin Energy requires that any tower crane or other temporary structure or equipment in the vicinity of a transmission facility be located in such a way as to eliminate the possibility of falling within 20 feet of the transmission facility if the crane or other temporary structure were to fail. If maintaining this distance is not possible, AE may be able to grant an exception, but would require a license agreement with a substantial liability insurance policy requirement.

1.14.10 Relocation of Transmission Facilities

While it is possible to relocate a transmission facility to accommodate development, it is costly and time-consuming, so it is not done very often. If a landowner/developer requests the relocation of a pole or a line, the landowner/developer would be required to pay all of the costs necessary for Austin Energy to do the work. The relocation work cannot negatively impact any adjacent properties. Because the structures are generally spaced as far apart as practical, moving a single structure could have a cascading effect, requiring the replacement/addition/relocation of other structures along the line, in order to maintain the required vertical and horizontal clearances.

Placing a transmission line underground is significantly more expensive than placing distribution facilities underground. Underground transmission work is roughly ten times the cost of overhead transmission. There are also operational impacts to undergrounding transmission that can increase the time and cost to restore power in the event of an issue. For these reasons, Austin Energy will not place transmission facilities underground to accommodate private development.

If you anticipate the need to relocate a transmission line or structure, contact AE as soon as practical, because transmission relocation projects can easily take years from start to completion.

1.14.11 Pipelines

Electric fields from power lines have been associated with issues with steel underground pipelines. Pipeline owners are responsible for all induced potential mitigation and grounding required for their pipelines.

The top of a gas pipeline must be buried 5 feet below grade and built to withstand a 48,000 lbs. tandem axle load.

Pipelines must be located a minimum of 25 feet from any transmission structure.

Where possible, a gas pipeline may intersect the transmission line easement at 45° or 90°.

Pipelines require a license agreement with Austin Energy prior to being placed in Austin Energy's easements.

1.15.0 DISTRICT ENERGY AND COOLING

1.15.1 District Energy and Cooling Overview

District energy and cooling meets customers' heating/ventilation/air-conditioning (HVAC) and other requirements through a network of underground equipment (including pipes and fiber conduit) serving multiple buildings in a particular service area. A district cooling plant distributes chilled water to customers' buildings through a set of heat exchangers in the customer's mechanical room. District energy facilities provide electricity or steam to customers. Austin Energy owns and operates district cooling facilities in the Central Business Zoning District, and the North Burnet/Gateway (NBG) Zoning District and district energy and district cooling facilities in the Mueller Planned Unit Development area. Austin Energy may expand into additional areas to meet customer demand. District energy and cooling provide benefits to developers, building owners, building occupants, and the general public by reducing initial capital investment costs for development, lowering operational expenses, increasing building space for other uses, and reducing environmental impacts by shifting electricity usage to times when renewable resources are available. District energy and cooling can also support green building certification. Austin Energy encourages customers proposing land development projects in or near the areas described above to contact Austin Energy's District Energy and Cooling business unit.

1.15.2 District Energy and Cooling Safety and Clearance Requirements

Any proposed construction projected to come within three feet of district energy or district cooling equipment (usually piping and fiber conduit) must meet the following safety requirements:

- (1) Construction must maintain the following minimum separations from district energy and district cooling equipment:
 - a) 24 inches below;
 - b) 24 inches right and left; and
 - c) 36 inches above.
- (2) District energy and cooling equipment must be identified on all sheets in a building plan and profile.
- (3) Work must be potholed to locate district energy and cooling piping and fiber conduit at proposed crossings and at 300-foot intervals along drill path if the proposed construction method is directional drill and the running line is parallel to a district energy or district cooling facility.
- (4) The Austin Energy District Energy and Cooling business unit must be contacted 24 hours before exposing or crossing district energy or district cooling equipment.
- (5) When work related to a project within three feet of district energy or cooling equipment requires the discharge of district cooling product, the following requirements apply:
 - a) The product must be analyzed prior to discharge from the system as it contains chemicals.
 - b) There must be no penetrations of district cooling equipment. District cooling product must be discharged only to a sanitary wastewater system and only with Austin Energy written approval.
 - c) If penetration of district cooling equipment occurs unintentionally, the Austin Energy District Energy and Cooling business unit should be contacted immediately.
 - d) Contractors must, at their own cost, repair damage to district energy and cooling equipment according to Austin Energy specifications.

- (6) Covers and lids for district energy and cooling underground vaults, valve risers, and air releases shall be maintained at final surface grade and shall not be obstructed or covered over.
- (7) Tree root barriers shall be placed on all sides of the planting zone where district energy and cooling pipes and/or services are located. Root barriers shall be installed between the tree roots and district energy and cooling infrastructure. The root barrier shall be no closer than 3 feet from district energy and cooling infrastructure. In no circumstances shall district energy and cooling infrastructure be placed within the planting zone.
- (8) District energy and cooling Submittal Review Board must review and approve landscaping plans before it can be placed above its infrastructure. Plans shall include the plant type and root ball information.

1.15.3 District Energy and Cooling Modifications

District Energy and Cooling infrastructure shall conform to DEC Standard and Special Specifications <https://www.austinenergy.com/go/dec>. If relocations are required, then easement acquisitions will need to be addressed if moving into private property. Easement information is located in DEC's Customer Connection Requirements <https://www.austinenergy.com/go/dec>.

- (1) Project Owner is responsible for all design and construction costs to relocate existing district energy or district cooling infrastructure.
 - (a) Connecting to existing district cooling pipes shall be done with hot taps and line stops.
 - (b) Only one modification of the district energy or district cooling distribution loop can occur at one time.
 - (c) Project Owner will pay for inspection costs for all district energy and cooling modifications. A district energy and cooling inspector must be onsite for any modification of their infrastructure.
- (2) Chilled water service cannot be shut down for any modification.
- (3) Project Owner will pay for hydraulic study to analyze effect of relocating district energy and cooling pipes. Pipes cannot be relocated without written approval from District Energy and Cooling.
- (4) All modifications to district cooling loops must occur between mid-November to end of February, except with written approval from District Energy and Cooling.

1.16.0 APPLICATION REQUIREMENTS FOR AUSTIN ENERGY LAND DEVELOPMENT REVIEW

A land development application must:

- (1) Include an electronic, georeferenced AutoCAD (version 2016 or newer) drawing, to scale and with north arrow, that shows the following:
 - i. Clearly delineated locations and extents of all public and private easements proposed including, but not limited to, electrical, gas, water, sewer, telecommunications, and drainage;
 - ii. Clearly delineated locations of all existing facilities including, but not limited to, electric transmission and distribution structures, guys, anchors, and transformers;
 - iii. Clearly delineated locations of all existing and proposed permanent structures showing footprint and height;
 - iv. Clearly delineated final proposed topology that includes grades, grade changes, floodplains, and detention ponds; and
 - v. Clearly delineated locations of property lines and building setbacks.
- (2) Demonstrate sufficient clearances for existing and proposed electric facilities and other electric system design and safety requirements described in this Manual or any other applicable Austin Energy design specifications, guides, standards, and City Code.
- (3) Demonstrate sufficient electric utilities easements to accommodate existing electric facilities and all electric facilities estimated to serve the development and that grant AE sufficient property rights to restrict development that would impede access to AE facilities. If current easements do not sufficiently cover existing and estimated facilities, then additional easement must be dedicated by the current owner to cover such facilities, and owner must, at owner's expense, provide AE with metes and bounds descriptions of all easement areas (easement areas to be determined by Austin Energy) for easement preparation. Any necessary electric facility relocation will be performed at the applicant's expense.
- (4) Demonstrate that the development will not limit the ability of Austin Energy personnel to access and maintain current and proposed electric facilities.
- (5) Identify one point of service and one service voltage unless more than one point of service or service voltage is allowed under the exceptions found in this Manual or the allowance is approved by Austin Energy.
- (6) Demonstrate approximate location and appropriate space for electric facilities, desired point of electric service, and provide projected load required for electric service.
- (7) Comply with all other Austin Energy requirements, specifically including without limitation Austin Energy safety requirements, found in this Manual or in any other applicable Austin Energy design specifications, guides, standards, and City Code.
- (8) Contain plat notes or provides for easement terms as follows:
 - i. Austin Energy has the right to prune and to remove trees, shrubbery and other obstructions to the extent necessary to keep all electric facility easements clear.
 - ii. The subdivision owner must provide Austin Energy with any easement and access required, in addition to those indicated, for the installation and ongoing maintenance of overhead and underground electric

facilities to provide electric service to the development and will not be located so as to cause the site to be out of compliance the City of Austin Land Development Code.

- iii. The owner is responsible for installation of temporary erosion control, revegetation and tree protection. In addition, the owner is responsible for the performance of any required initial tree pruning and tree removal for vegetation that is within ten feet of the center line of the proposed overhead electrical facilities designed to provide electric service to this project. The limits of construction for the owner's project shall include Austin Energy's work area.
 - iv. The property owner is responsible for maintaining clearances required by the National Electrical Safety Code, National Electrical Code, OSHA regulations, City of Austin rules and regulations and Texas state laws pertaining to clearances when working in close proximity to overhead power lines and equipment. Austin Energy will not render electric service unless required clearances are maintained. All costs incurred by AE as a result of an owner's failure to maintain required clearances will be charged to and shall be the responsibility of the property owner.
 - v. If a transmission easement (existing, proposed, or prescriptive) is on the property, then Owner may not place, erect, construct or maintain the following within an electric transmission easement:
 - 1. any permanent structures, including, but not limited to habitable structures such as homes, mobile homes, garages, or offices;
 - 2. any structure of any kind in such proximity to the electric transmission or distribution lines, poles, structures, towers, or appurtenant facilities that would constitute a violation of the National Electrical Safety Code in effect at the time the structure is erected;
 - 3. or any structures, including but not limited to, fences, storage sheds, drainage, filtration or detention ponds which would impair Austin Energy's access to the transmission easements or its lines, poles, structures, towers or appurtenant facilities in the easements.
 - vi. If a transmission easement (existing, proposed, or prescriptive) is on the property, then the property owner and owner's agents must provide Austin Energy with 24-hour access across the property to the transmission easement for the installation and ongoing maintenance of electric facilities.
 - vii. If a transmission easement (existing, proposed, or prescriptive) is on the property, then all roads and driveways which cross or parallel the transmission easement must be built to sustain not less than 48,000 lbs. tandem axle load within the easement to ensure safety and access by Austin Energy and their contractors.
 - viii. If a transmission easement is on a property subject to a future site plan or construction, all construction activity or grading within the easement must be coordinated with Austin Energy prior to commencement, and AE must be provided with a minimum of a 48-hour notice prior to the commencement of construction or grading. Call Andrew Perez at 512-505-7153 to schedule a meeting 48 hours prior to commencement.
- (9) Label any land within a transmission easement (existing, proposed, or prescriptive) as parkland or propose any land within a transmission easement (existing, proposed, or prescriptive) to be dedicated as parkland.

Land development projects that will be served by an electric utility other than Austin Energy must follow the applicable electric utility process of that utility for design and construction of electric facilities and other requests related to electric service.

1.17.0 GLOSSARY

Apartment(s) and Apartment Building(s)	A single residential unit consisting of five or more individual residential dwellings or multiple buildings or residential units with multifamily dwellings in each building. (This term does not apply to “apartment house” as that term is used in Section 1.9.4 regarding submetering for residential and commercial properties.)
Attachment Height(s)	The distance above final grade or other accessible surface to the location of the one-point rack (or the lowest mounted rack of a three- or four-point rack). The lowest mounted rack shall be installed at the service drop attachment height and within 12 inches below the weatherhead.
Building	Common foundation and common roof.
BSPA	The Building Service Planning Application is the document submitted by the builder or customer to AE’s Development Assistance Center reviewer that provides the specifics of the customer’s request to develop a certain piece of property. An electronic copy of the BSPA may be obtained from the Development Services Department website under the Residential Building Review section.
City (COA)	The City of Austin or any employee or designee authorized to represent the COA.
Civil Work	Civil work refers to underground conduit, service-boxes, pull-boxes, duct-structure, manholes, pad-mounted equipment foundations (pads), etc.
Commercial	Any building, structure, or facility that does not meet the definition of “Residential Dwelling, Residential Unit, Condominium, or Apartment”.
Condominium	An apartment building in which the apartments are owned by individuals, but all the land and other property are owned jointly.
Construction Standards	Detailed criteria and instructions for the construction and installation of Austin Energy facilities.
Costs: Excess Facilities	AE provides the facilities for permanent basic standard electric service based on the estimated steady state electrical demand load as determined by AE Design from the Customer’s connected load information. Excess facilities is anything more than what AE would provide to serve the estimated load.
CT	Current Transformer
Customer	Any present or prospective user of electric service or the developer, architect, engineer, electrical contractor, builder or other person representing a present, prospective, or future user of electric service from Austin Energy.
Customer’s Electric Equipment	Equipment that is owned and maintained by the customer.

Demand	<p>Demand is a measure of electrical power magnitude, not total energy usage. Demand is used in two contexts in this Design Criteria – 1) metering demand which is the power used by the Customer averaged over a 15-minute time interval and 2) electrical demand which is the actual power flowing in the AE facilities. (These values will be determined by AE Design for the purposes of sizing AE facilities and may differ significantly from the Customer’s undiversified total connected load which is the sum total of manufacturer’s name plate/equipment watt or ampere ratings for all of the Customer’s electrical load.)</p> <p>Metering Demand is usually expressed in kilowatts (kW) and is the Customer’s load registered by the AE demand meter.</p> <p>Electrical Demand for AE design purposes is the <i>steady state</i> maximum load expressed in kilovolt-amps (kVA) or in amps depending upon how the specific AE electrical facilities in question are rated used to design and size AE facilities.</p> <p>Peak Demand for AE design purposes is <i>instantaneous</i> peak electrical demand (also expressed in kilovolt-amps or amps) used to design and size AE facilities for Customer equipment having a high short-term and/or intermittent demand load characteristics (such as experienced during motor starting or from electrical welding equipment).</p>
Distribution	Electric facilities energized or capable of being energized at voltages of less than 60Kv phase-to-phase.
District Energy and Cooling Equipment	Any equipment used, designed to be used, or installed for use, to conduct, control, convert, distribute, generate, measure, provide, rectify, store, transform, or transmit chilled water as part of Austin Energy’s chilled water systems, including fiber optic cable and associated conduit.
District Energy and Cooling Business Unit	The Austin Energy business unit that operates District Energy and Cooling equipment to produce, generate, transmit, distribute, sell, or furnish energy, steam or chilled water to end-use customers.
District Cooling Plant	A centralized Austin Energy plant supporting Austin Energy’s chilled water system.
District Energy Plant	A centralized Austin Energy plant providing steam and/or electricity to a specific customer and operated by the Austin Energy District Energy and Cooling business unit.
Electrical Equipment or Electric Equipment	Any equipment used, designed to be used, or installed for use, to conduct, control, convert, distribute, generate, measure, provide, rectify, store, transform, or transmit electrical energy as part of AE’s electric transmission and distribution system.
Electrical Facilities or Electric Facilities	Any line, equipment, or supporting structure used or capable of being used to carry, transmit, control, distribute, generate, or store electrical energy.

Electric Service Planning Application (ESPA)	The Electric Service Planning Application (ESPA) is the document submitted by the Customer to Austin Energy that gives AE the specifics of the Customer's request and (if applicable) the requirements of the Customer's total connected load associated with the Customer's request for electric service.
Fee Schedule	The AE fee schedule can be found at https://austinenergy.com/ae/rates/approved-rates-schedules
Full Current Neutral	The neutral conductor(s) must have the full current-carrying capacity of the largest energized conductor(s) and be installed from the Customer's point of service to the Customer's service disconnect(s) at the service equipment. The neutral conductor must be properly marked and grounded.
Group/Grouped	To put together in one place or location (Ex.: meter and disconnect are to grouped together in a common location).
High Voltage	601 volts or higher
High Accuracy CTs	CTs that have an accuracy class of .15 or .15s (required for Austin Energy billing purposes)
Infrastructure	Infrastructure as it applies to the AE system refers to everything (poles, structures, transformers, primary & secondary conductors, down guys, conduit, manholes, equipment pads, equipment, etc.) except AE services and AE metering equipment.
Instrument Rated Metering	Any metering that requires other instruments, such as current or voltage transformers, to meter the load.
Large Commercial and Large Residential Metering	Any service at or above a main disconnect or combination of main disconnects of 350 amps single phase or 225 amps three phase, primary metering, fire pumps, or special metering.
Line Extension Policy	See Section 1.3.12
Main Disconnect	A mechanical switching device used for connecting and disconnecting the Customer's electric equipment from the AE electric supply system.
Main Line Distribution	Main line distribution is any overhead or underground distribution line that contains a major electrical feeder that supplies power to minor laterals. The major electrical lines are larger-sized cables such that a major overhead line is typically 795 MCM, and a major underground line is typically 1000 MCM in 5-inch conduit. Some variations may occur on the exact cable and conduit size for main line.
Major Project	A major project is defined as a project pertaining to the extension, expansion, or improvement of the AE distribution primary voltage feeder/network infrastructure system.

Man-Hole	A flush-mounted (installed to finished grade) concrete (or other) enclosure (as specified by AE Design or AE Network Design) used for installing and splicing AE primary voltage cables and/or other equipment (as specified by AE Design).
Mobile Home, Modular Home, and Manufactured Home Parks	A tract of land divided into lease spaces or lots and occupied by mobile homes, modular homes, and/or manufactured homes owned or leased by occupants.
Network Area	The underground and vault-only electric service area including all of downtown Austin and some of the immediately adjacent areas as shown by the Network Area Map in Section 1.12.4.
National Electrical Code (NEC)	The most recently adopted NEC as modified by the Austin City Council.
National Electrical Safety Code (NESC)	The national code that provides requirements in the design and construction of overhead and underground electric supply facilities on the utility-side of the point of service.
Occupational Safety and Health Administration (OSHA)	OSHA is the federal agency responsible for protecting worker health and safety and developing OSHA codes (i.e., regulations) to ensure safe working environments.
Point of Attachment	The physical location where AE will attach its infrastructure conductors (service conductors) to the customer's structure or meter loop pole attachment.
Point of Service (POS)	Unless otherwise specified in the Agreement for Electric Service (Letter of Agreement), the point of service is the point (weatherhead, meter socket, service distribution enclosure, pull-box, or other approved by AE Design) at which AE's and Customer's conductors are connected or terminated. Contact AE Design or AE Spots & Conduit for questions about the location of the point of service. AE shall make all connections at the point of service.
Pull-box	A flush-mounted (installed to finished grade) concrete (or other as specified) enclosure (typically 36 inches or 48 inches or as specified by AE Design or AE Network Design) used for installing and splicing AE primary voltage cables and secondary and service lateral cables.
Rack(s), One-point Rack(s)	A noncombustible, nonabsorbent insulator secured to the building or structure, using a minimum 1/2-inch diameter threaded bolt with nut and washers, for attachment of the AE's service-drop conductors. The rack(s) installation shall withstand 400 lbs of overhead service-drop conductor tension. AE SHALL FURNISH AND THE CUSTOMER SHALL INSTALL AND MAINTAIN THE RACK(S). (See "One-point Rack" section 1.18.0 Appendix and Exhibits)
Readily Accessible	In accordance with 29 CFR 1910.399, Readily accessible is defined as "capable of being reached quickly for operation, renewal, or inspections, without requiring those to whom ready access is a requisite to climb over or remove obstacles or to resort to portable ladders, chairs, etc."

Residential Dwelling	Residential dwelling is a general term that includes mobile homes, modular homes, manufactured homes, and buildings containing one-family, two-family (i.e., duplex), or multifamily (three or more) residential units.
Residential Unit	A residential unit normally refers to one residential structure. For the purpose of providing electric service, AE will treat duplexes, triplexes, and quadruplexes as a single residential unit except that each of the residential dwellings shall be individually metered unless approved by AE for submetering, and all the meters must be grouped at the AE designated location. Apartments are residential units that house five or more residential dwellings.
Safety Clearances	A minimum distance between a building or other object or structure that is needed to prevent the risk of death, bodily injury, or property damage from occurring due to contact with or proximity to an energized electric facility.
Secondary Voltage	600 volts or lower
Self-Contained Metering	A meter that can meter the load on its own without the need for additional equipment.
Service(s)	Service is a general term and is used in three contexts in this Design Criteria. AE is an electrical energy service utility, so the first use of the term service refers generally to the electrical energy AE supplies to the Customer. The <i>second</i> usage refers to the actual service installation -- the AE service conductors for delivering electric power from AE's supply system to the point of service (such as the weatherhead, meter socket, service distribution enclosure, pull-box, transformer, and primary meter enclosure). And finally, term "service" is used to refer generally to the service conductors on the source or load side of the AE meter up to the Customer's disconnect (either AE- or Customer-owned).
Service Area	The area served by AE generally includes the area within the corporate limits of the City of Austin, the general metropolitan area, and certain adjacent rural areas. Inquiries concerning the availability of service and adequacy of service should be made through AE Design.
Service-Box	A flush-mounted (installed to finished grade) concrete (or other as specified) enclosure (typically 18 inches or as specified by AE Design) used for installing and splicing one service lateral (350 kcmil maximum).
Service Conductors	A general term that refers to the overhead or underground secondary voltage conductors that are installed from the AE transformer or secondary conductors to the weatherhead, meter socket, or service distribution enclosure.
Service Conduit(s)	The raceway/wireway(s) used to enclose and protect the service conductors.

Service Policy	<p>City of Austin Rate Schedule - Line Extension and Electrical Switchover Policy (Extension of Service Section)</p> <p>Defines the AE cost versus revenue requirements for all electric service extensions and the limited AE obligation to provide nominal or no cost 120/240V single-phase service to small, seasonal, or intermittent electrical loads (see Section 1.3.11)</p>
Service Required/ Service Need Date	<p>These terms refer to the date that the Customer requests or needs electric service from AE. It is a tentative date at the start of the process because this date is always dependent upon the Customer actually requesting service, which involves setting up an account with AE and submitting an approved ESPA form with permit # to AE Design, and completing all the necessary work, permits, and inspections with enough lead-time before the need date to allow ample time for AE scheduling and construction. The lead-time needed to schedule crews, order materials, and complete construction depends on such things as workload and weather. Contact AE Design for approximate lead-time information for Customer planning purposes. Note: All permits, easements, inspections, and AE requirements must be completed before the project will be scheduled and an actual construction date can be determined.</p>
Service Distribution Enclosure (SDE)	<p>Generally used for underground installations for multiple-meter/shell commercial buildings and for multiple-meter residential buildings. This is an above-grade enclosure (SDE, junction box, J-Box, or tap-box) that may be designated as the point of service by AE.</p> <p>HIGHLY RECOMMENDED: Contact the Development Assistance Service Center or the COA DSD Building Inspections division for information and written approval prior to purchasing and installation of Service Distribution Enclosure.</p>
Service-Only	<p>AE secondary voltage source and capacity are available at the site and no AE infrastructure construction is required.</p>
Service-Drop	<p>The overhead secondary voltage service conductors from AE's last or closest voltage source facilities on the AE distribution infrastructure (i.e. pole) up to and including the connections to the Customer's service conductors located on the exterior finished surface of the building or structure. The overhead service-drop conductors are furnished, installed, owned, and maintained by AE.</p>
Service Lateral	<p>The underground secondary voltage service conductors from AE's last or closest voltage source infrastructure facility (i.e. transformer, pull-box/service-box, etc.) to the Customer's building or structure. The point of service location determines whether AE or the Customer furnishes, owns, and maintains the service lateral conductors.</p>

Shell Building	A commercial structure (new or existing) with individually metered tenant spaces that are constructed on a speculative basis with no definite knowledge of potential Customer usage or electrical load requirements. (AE may charge the install and remove costs for the initial interim service until the permanent Customer's load requirements can be determined.) See Section 1.5.2.9.
Small Commercial and Small Residential Metering	Any service at or below a main disconnect or combination of main disconnects of 350 amps single phase or 225 amps three phase.
Speculative Building	A building constructed for rent, lease, or sale for which the permanent Customer's electrical load and usage characteristics are unknown. The initial and interim electrical service to speculative buildings is treated as temporary service. See sections 1.5.2.9 and 1.7.1.
Spot (verb)	Identification of the point of service and Austin Energy's requirements at the point of attachment. Spots are performed by the Spots and Conduit group.
Standard Electric Service	Standard electric service is a single source, single-phase, radial, overhead service provided on wood poles, except in the Network Area.
Structure	A combination of materials to form a construction for occupancy, use or ornamentation, whether installed on, above or below the surface of a parcel of land, provided the word "structure" shall be construed when used herein as though followed by the phrase "or part or parts thereof and all equipment therein" unless the context clearly defines a different meaning.
Substation	A substation is an AE facility that changes voltage levels between Transmission (69kV, 138kV, 345kV) and Distribution (12.47kV, 34.5kV) equipment or serves as a switching point to connect multiple transmission lines.
Townhouses	A single-family dwelling unit constructed in a row of attached units separated by property lines and with open space on at least two sides.
Treated Pole	A treated pole shall meet the requirements of the American Wood Preservers' Association's latest edition (such as creosote, pressure-treated, and similar substances).
Transmission	Electrical facilities energized or capable of being energized at voltages of 60kV phase-to-phase or higher.

Vault

A securable concrete room or enclosure installed by the Customer on the Customer's property (typically within the footprint of the Customer's building or structure). The vault is locked with an AE lock, and accessible only to AE personnel (as specified by AE Network Design or AE Design). It is used for housing only AE equipment, transformers, and other as specified by AE Network Design or AE Design.

(See Section 1.12.0 for general requirements for Network Area vaults and contact AE Design for distribution area vault requirements.)

VT

Voltage Transformer

1.18.0 APPENDIX AND EXHIBITS

Figure 1-11. Instrument Rated (IR) Meter Socket(s) Enclosure (Typical for Pad-Mounts)

1-11	METERING INSTRUMENT RATED METER SOCKET ENCLOSURE TYPICAL INSTALLATION	
SHEET 1 OF 1		
11/15/22		

MATERIAL NOTES:

- CONSTRUCT SUPPORT STRUCTURE USING 12-GAUGE STEEL-SLOTTED CHANNEL UNISTRUT METAL FRAMING, ANGLE FITTINGS, BOLTS AND NUTS AS SHOWN. THE SUPPORT STRUCTURE SHALL BE STATIONARY. ADDITIONAL BRACING MAY BE REQUIRED.
- 3/8" THREADED ANCHOR BOLTS IN CONCRETE SHALL HAVE A MIN. PULL-OUT STRENGTH OF 2000 lbs.

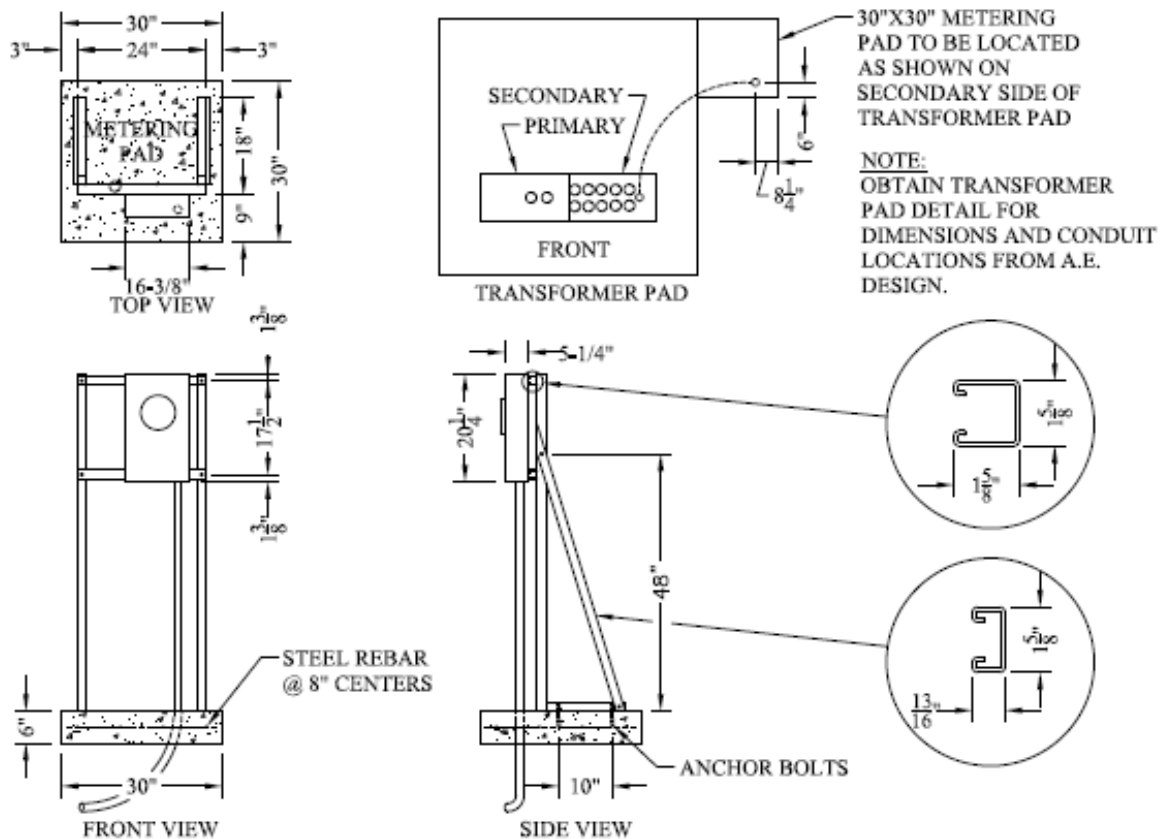

NOTES: 13 TERMINAL 3 PHASE CT RATED

- METERING AT THE TRANSFORMER PAD IS ONLY AVAILABLE FOR SINGLE METER INSTALLATION.
- CURRENT TRANSFORMERS TO BE INSTALLED AT THE SECONDARY BUSHINGS OF THE TRANSFORMER BY AUSTIN ENERGY.
- METER ENCLOSURE SHALL BE INSTALLED FACING THE FRONT OF THE TRANSFORMER PAD.
- INSTALL METER CONTROL CABLE CONDUIT (1-1/4" SCHEDULE 80 PVC OR RIGID METAL) TO ENTER METER ENCLOSURE AT BOTTOM-RIGHT.
- ALTERNATE LOCATION: WITH APPROVAL OF THE ELECTRIC METER OPERATION SECTION, THE METER ENCLOSURE MAY BE INSTALLED ON A PERMANENT WALL WITHIN SIGHT (VISIBLE AND NOT MORE THAN 30 FEET) FROM THE TRANSFORMER PAD.
- STEEL BARRIER POSTS WILL BE REQUIRED WHEN THE TRANSFORMER PAD IS INSTALLED WITHIN 4 FEET OF A TRAFFIC AREA.
- HEIGHT TO CENTER OF THE METER SOCKET OPENING FROM A PERMANENT STANDING SURFACE SHALL BE 48"-72".
- RUN A #6 GROUND WIRE (EITHER SOLID OR STRANDED) FROM THE SECONDARY COMPARTMENT OF THE PAD MOUNT TRANSFORMER TO THE METER SOCKET. BOND THE GROUND WIRE TO THE METER SOCKET, AND INSTALL A PULL STRING.
- WHEN USING A VT ENCLOSURE AND A STANDARD METER SOCKET OR VT/METER COMBO SOCKET, THE 1 1/4" CONDUIT FROM THE TRANSFORMER MUST HIT THE VT SIDE OR VT ENCLOSURE SIDE FIRST.

Figure 1-12. One-Point Rack (Typical)

I-12	INSULATORS ONE-POINT RACK (TYPICAL)	
SHEET 1 OF 1		
-		

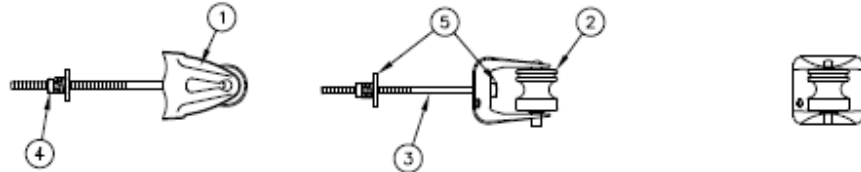

1. RACK PULLY TYPE 1 POINT (1)
2. 3 INCH INSULATOR SPOOL (1)
3. 1/2 INCH THREADED BOLT (x LENGTH REQUIRED) WITH SQUARE HEAD (1)
4. 1/2 INCH NUT (1)
5. 1/2 INCH WASHERS x 2-1/4 INCHES (2)

A NONCUMBUSTABLE, NONABSORBENT INSULATOR SECURELY ATTACHED TO A BUILDING OR STRUCTURE, POLE, ETC. FOR ATTACHMENT OF AUSTIN ENERGY SERVICE DROP CONDUCTORS. THE ONE-POINT RACK SHALL WITHSTAND 400 LBS. TENSION.

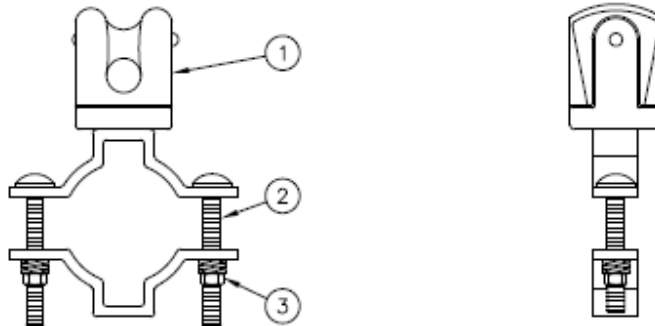

- ① PORCELAIN INSULATOR (1) OR A.E APPROVED EQUIVALENT
- ② CARRIAGE BOLT (2)
- ③ HEXNUT WITH LOCK WASHER (2)

A NONCUMBUSTABLE, NONABSORBENT INSULATOR SECURELY ATTACHED TO A THROUGH ROOF SERVICE MAST FOR ATTACHMENT OF AUSTIN ENERGY SERVICE DROP CONDUCTORS. SERVICE MAST SHALL BE 2" MIN. RIGID METAL. THE ONE-POINT RACK SHALL WITHSTAND 400 LBS. TENSION.

Figure 1-13. Portable Meter Loop for Temporary Overhead Construction Service (Typical Installation)

1-13	PORTABLE METER LOOP—OVERHEAD CONSTRUCTION SERVICE RESIDENTIAL 120/240 VOLT SINGLE PHASE (TYPICAL)	
SHEET 1 OF 1		
11/14/21		

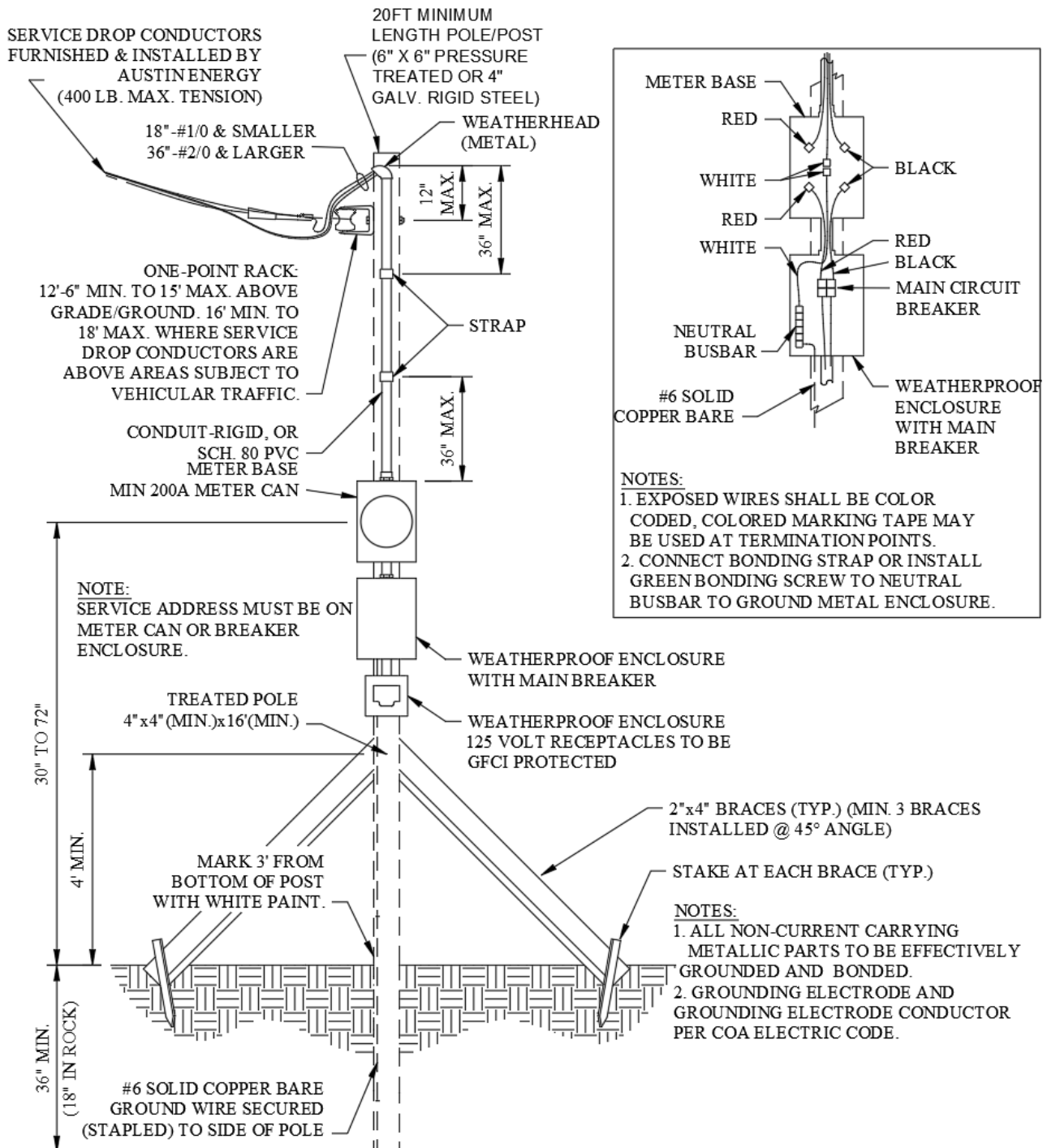
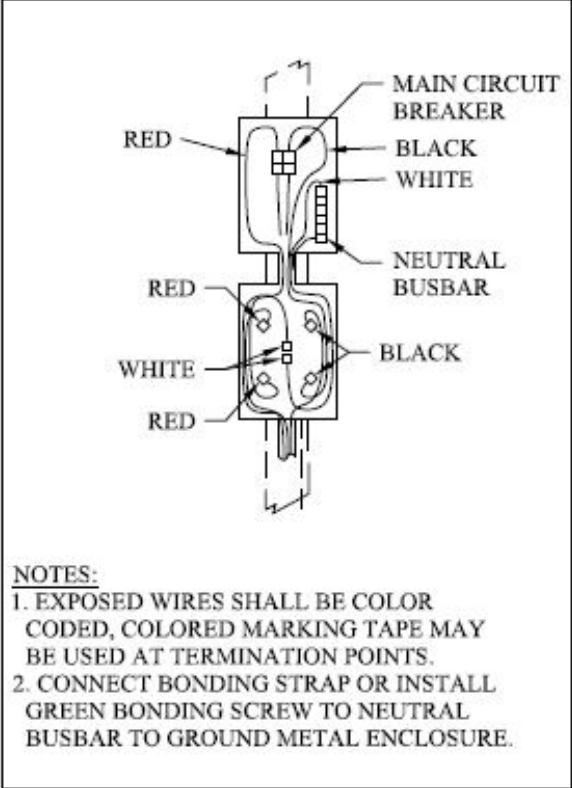
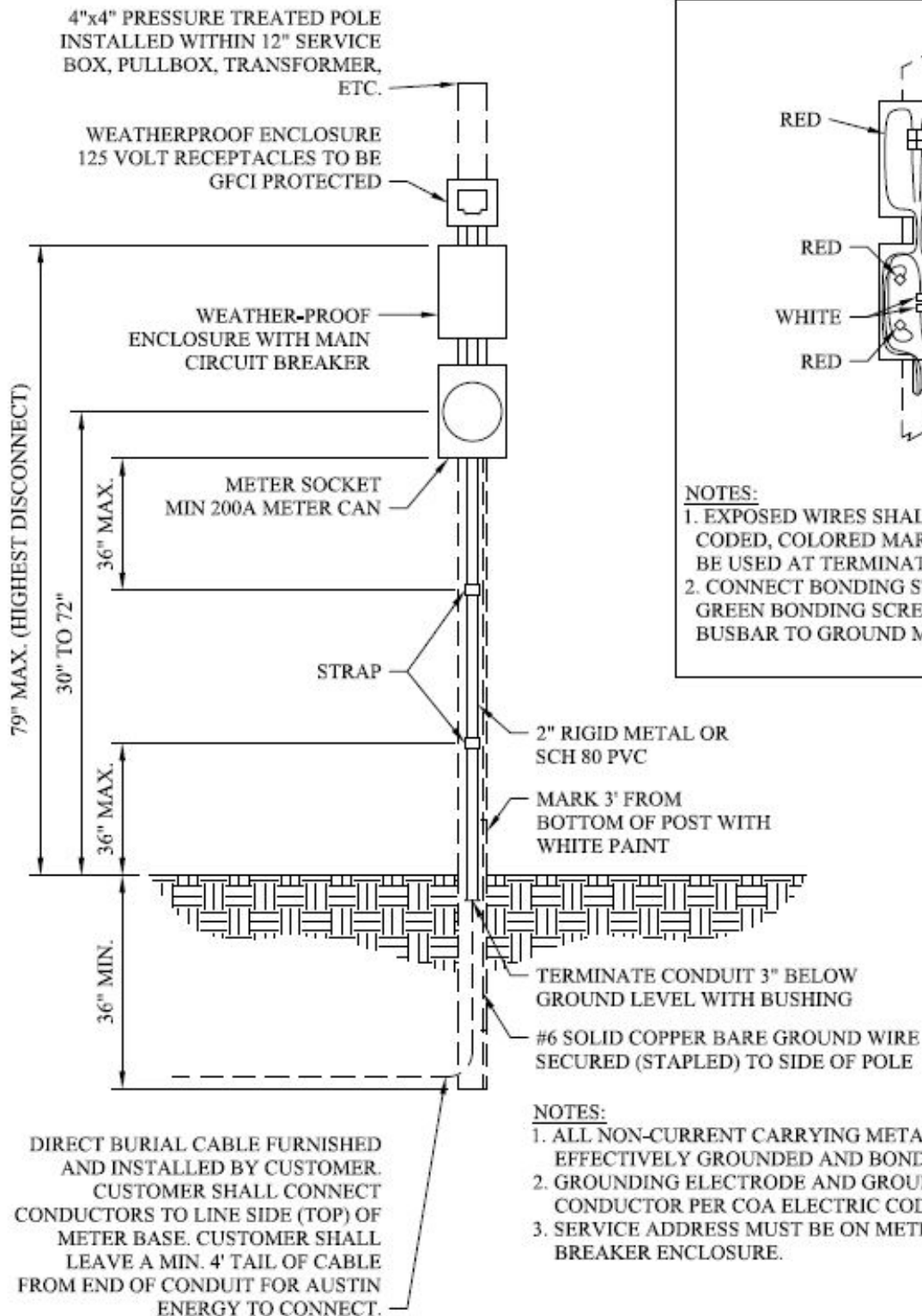

Figure 1-14. Portable Meter Loop for Temporary Underground Construction Service (Typical Installation)

1-14	PORTABLE METER LOOP FOR TEMPORARY UNDERGROUND SERVICE 120/240 VOLT SINGLE PHASE-CONST SERVICE (TYP. INSTALLATION)	
SHEET 1 OF 1		
11/14/21		



- NOTES:**
1. EXPOSED WIRES SHALL BE COLOR CODED, COLORED MARKING TAPE MAY BE USED AT TERMINATION POINTS.
 2. CONNECT BONDING STRAP OR INSTALL GREEN BONDING SCREW TO NEUTRAL BUSBAR TO GROUND METAL ENCLOSURE.

- NOTES:**
1. ALL NON-CURRENT CARRYING METALLIC PARTS TO BE EFFECTIVELY GROUNDED AND BONDED.
 2. GROUNDING ELECTRODE AND GROUNDING ELECTRODE CONDUCTOR PER COA ELECTRIC CODE.
 3. SERVICE ADDRESS MUST BE ON METER CAN OR BREAKER ENCLOSURE.

Figure 1-15A. Meter Loop for Permanent Overhead Service Installation (Typical Residential Installation)

1-15A	METER LOOP FOR PERMANENT OVERHEAD SERVICE INSTALLATION	
SHEET 1 OF 1	RESIDENTIAL 120/240 VOLT SINGLE PHASE TYPICAL INSTALLATION	
11/9/23		

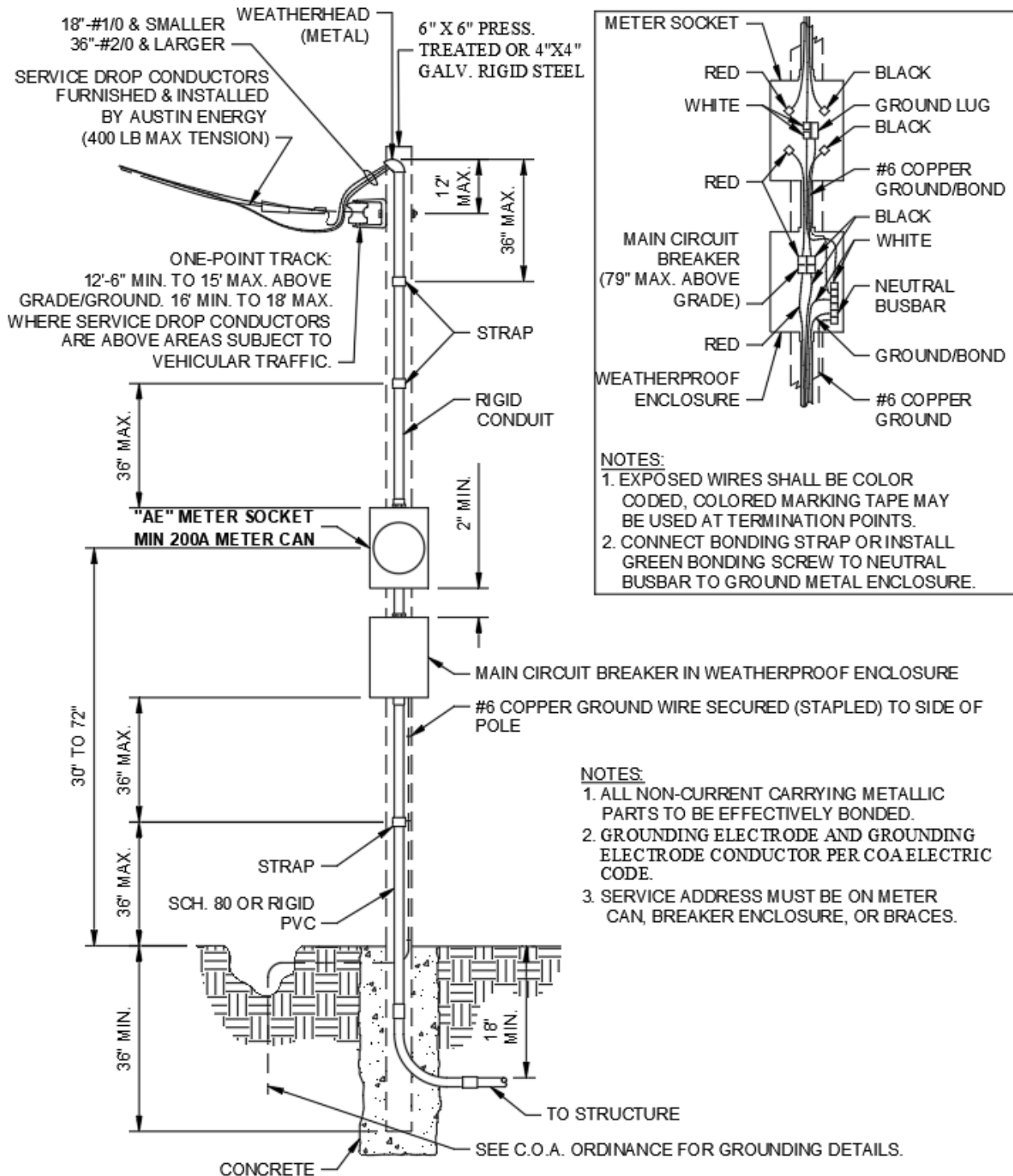

Figure 1-15B Meter Loop for Permanent Overhead Service Installation (Residential-Typical Installation)

1-15B	METER LOOP FOR PERMANENT OVERHEAD SERVICE	RESIDENTIAL 120/240 VOLT SINGLE PHASE (TYP. INSTALLATION)	
SHEET 1 OF 1			
11/14/21			

See contact information in Section 1.2.0.

MATERIAL LIST FOR SERVICE ONLY. DOES NOT INCLUDE MATERIAL FROM MAIN CIRCUIT BREAKER TO STRUCTURE. MATERIAL LIST IS APPROXIMATE AND FOR SUGGESTION ONLY. USE STRANDED AND INSULATED WIRE IN CONDUIT. GROUND/BOND WIRE MAY BE NONINSULATED.

		SERVICE SIZE (AMPS):					
		100	125	150	175	200	225
QTY.	MATERIALS	SIZE/SPECIFICATIONS					
1	WEATHERHEAD (METAL)	1-1/4"	1-1/4"	1-1/4"	2"	2"	2"
1	ONE POINT RACK(FURNISHED BY CUSTOMER)	WITH THREADED BOLT, NUT, & WASHER					
1	TREATED POLE	6"x6" MIN. x 20' MIN. (20' MIN. IF SERVICE DROP IS OVER DRIVEWAY)					
10	RIGID (ELECTRICAL METALLIC TUBING)	1-1/4"	1-1/4"	1-1/4"	2"	2"	2"
2	RIGID STRAPS (STAND-OFF)	1-1/4"	1-1/4"	1-1/4"	2"	2"	2"
1	RIGID RAIN-TIGHT CONNECTOR	1-1/4"	1-1/4"	1-1/4"	2"	2"	2"
2	HUB (METAL)	1-1/4"	1-1/4"	1-1/4"	2"	2"	2"
1	METER SOCKET (FURNISHED BY CUSTOMER)	150 200-S	150 200-S	150 200-S	200-S	200-S	200-S
1	4" LONG RIGID GALVANIZED NIPPLE x	1-1/4"	1-1/4"	1-1/4"	2"	2"	2"
2	LOCKNUTS (METAL)	1-1/4"	1-1/4"	1-1/4"	2"	2"	2"
1	PLASTIC BUSHING	1-1/4"	1-1/4"	1-1/4"	2"	2"	2"
1	MAIN CIRCUIT BREAKER IN WEATHERPROOF ENCLOSURE	100 AMP	125 AMP	150 AMP	175 AMP	200 AMP	225 AMP
40'	THHN/THWN COPPER WIRE	#4	#2	#1	#1/0	#2/0	#3/0
40'	COPPER GROUND WIRE-BARE	#6	#6	#6	#6	#6	#6
	CONCRETE MIX	TO FILL HOLES AROUND POLES (3' DEEP MIN.)					
	COLOR MARKING TAPE (eg.; WHITE, RED)	TO MARK WIRE AT TERMINATION POINTS					

Figure 1-16A. Meter Loop for Permanent Underground Service Installation (Residential/Commercial - Typical Installation)

1-16A	METER LOOP FOR PERMANENT UNDERGROUND SERVICE INSTALLATION	
SHEET 1 OF 1	RESIDENTIAL 120/240 VOLT SINGLE PHASE TYP INSTALLATION	
11/15/22		

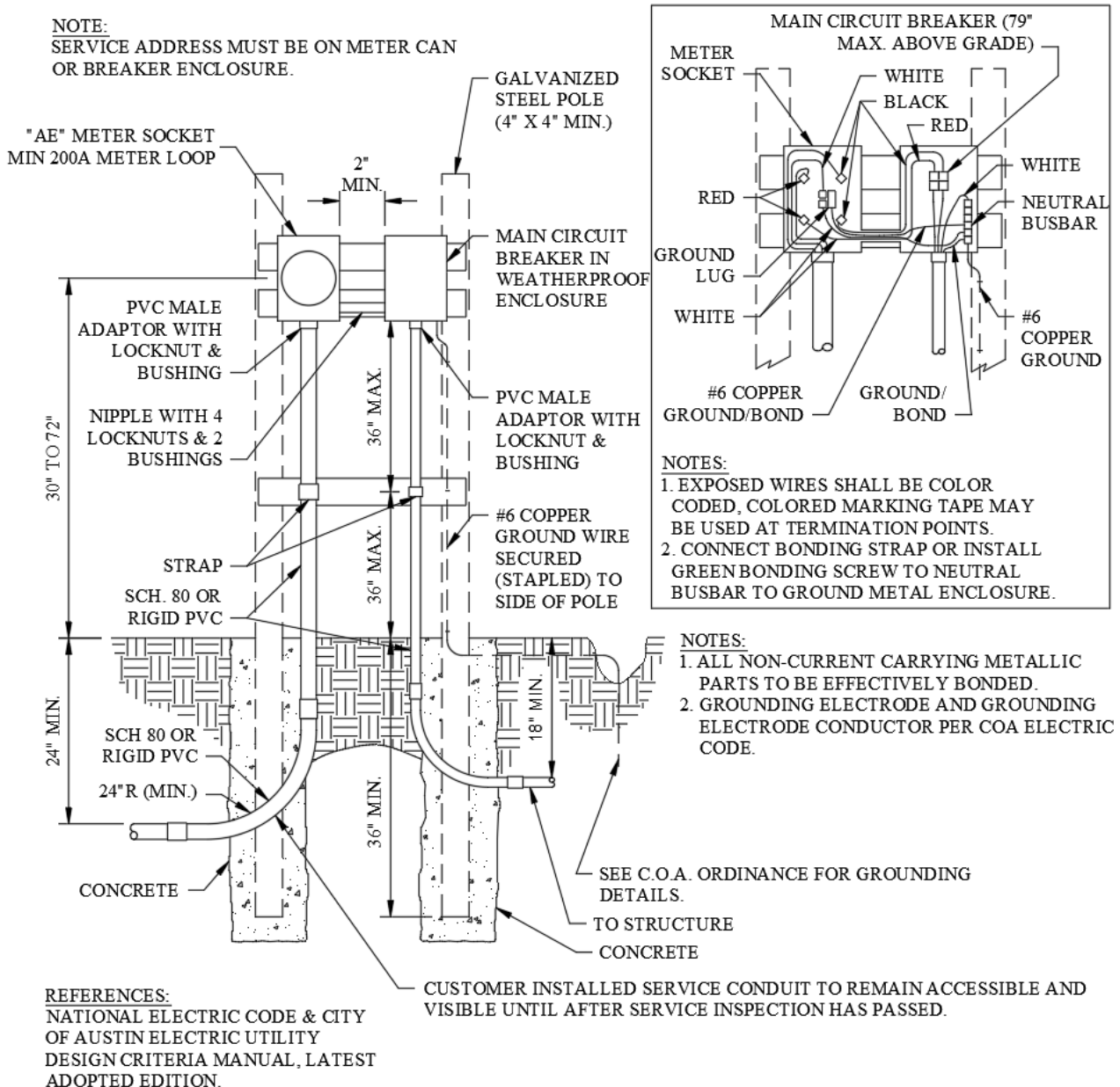

**Figure 1-16B. Meter Loop for Permanent Underground Service Installation
(Residential/Commercial - Typical Installation)**

1-16B	METER LOOP FOR PERMANENT UNDERGROUND SERVICE RESIDENTIAL 120/240 VOLT SINGLE PHASE (TYP. INSTALLATION)	
SHEET 1 OF 1		
11/14/21		

MATERIAL LIST FOR SERVICE ONLY. DOES NOT INCLUDE MATERIAL FROM MAIN CIRCUIT BREAKER TO STRUCTURE. MATERIAL LIST IS APPROXIMATE AND FOR SUGGESTION ONLY. USE STRANDED AND INSULATED WIRE IN CONDUIT. GROUND/BOND WIRE MAY BE NONINSULATED.

SERVICE SIZE (AMPS):		100	125	150	175	200	225
QTY.	MATERIALS	SIZE/SPECIFICATIONS					
2	PRESSURE TREATED POST	4"x4" MIN. x 5' OR 10'					
12'	PRESSURE TREATED WOOD	2"x4" MIN.					
10'	SCH 80 PVC * Δ	2"	2"	2"	2"	2"	2"
1	SCH 80 PVC MALE ADAPTOR *	2"	2"	2"	2"	2"	2"
1	SCH 80 PVC COUPLING *	2"	2"	2"	2"	2"	2"
1	SCH 80 PVC 90° ELBOW *	2"	2"	2"	2"	2"	2"
1	PVC STRAP	2"	2"	2"	2"	2"	2"
1	LOCKNUT (METAL)	2"	2"	2"	2"	2"	2"
1	PLASTIC BUSHING	2"	2"	2"	2"	2"	2"
1	METER SOCKET (FURNISHED BY CUSTOMER)	200-S	200-S	200-S	200-S	200-S	200-S
1	4" LONG RIGID GALVANIZED NIPPLE x	1-1/4"	1-1/4"	1-1/4"	2"	2"	2"
4	LOCKNUTS (METAL)	1-1/4"	1-1/4"	1-1/4"	2"	2"	2"
2	PLASTIC BUSHING	1-1/4"	1-1/4"	1-1/4"	2"	2"	2"
1	MAIN CIRCUIT BREAKER IN WEATHERPROOF ENCLOSURE	100 AMP	125 AMP	150 AMP	175 AMP	200 AMP	225 AMP
10'	THHN/THWN COPPER WIRE □	#4	#2	#1	#1/0	#2/0	#3/0
40'	COPPER GROUND WIRE-BARE	#6	#6	#6	#6	#6	#6
	CONCRETE MIX	TO FILL HOLES AROUND POLES (3' DEEP MIN.)					
	COLORED MARKING TAPE (eg. WHITE, RED)	TO MARK WIRE AT TERMINATION POINTS					

* ELECTRIC SCH 80 PVC-GRAY COLOR

Δ DOES NOT INCLUDE PVC FROM 90° BEND TO SERVICE BOX.

□ WIRE FROM METER SOCKET TO MAIN CIRCUIT BREAKER

SOUTH:
ST. ELMO SERVICE CENTER
4411-B MEINARDUS DRIVE
DISPATCH OFFICE 505-7620

NORTH:
KRAMER LANE SERVICE CENTER
2526 KRAMER LANE, BLDG. "E"
METER SHOP 505-7167

Figure 1-17. Under-Eaves Service Installation (Residential – Typical Overhead Installation)

1-17	UNDER-EAVES SERVICE INSTALLATION	
SHEET 1 OF 1	RESIDENTIAL 120/240 VOLT SINGLE PHASE TYP. INSTALLATION	
11/2/23		

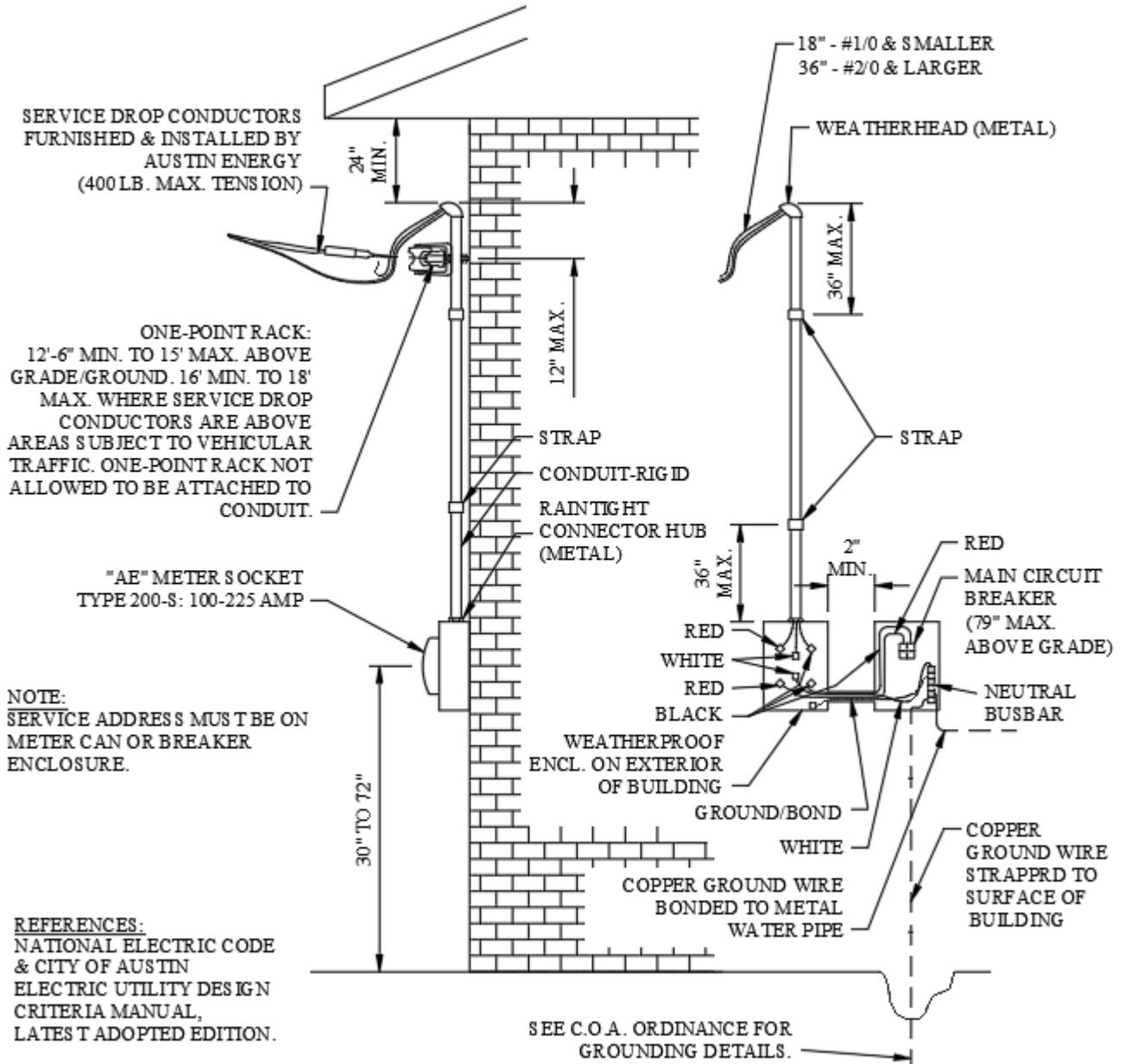
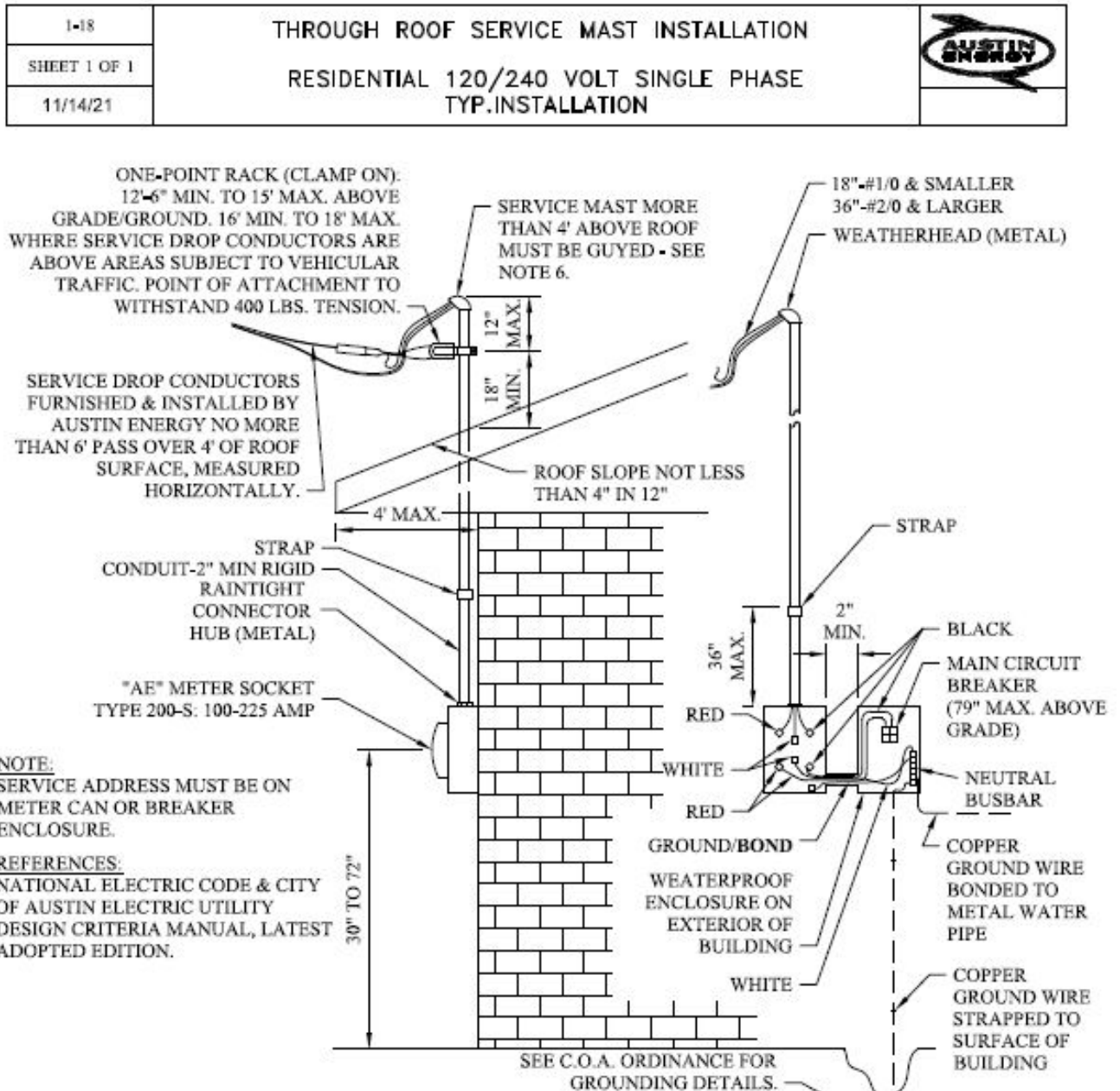

Figure 1-18. Through-Roof Service Mast Installation (Residential – Typical Overhead Installation)



NOTE:
SERVICE ADDRESS MUST BE ON METER CAN OR BREAKER ENCLOSURE.

REFERENCES:
NATIONAL ELECTRIC CODE & CITY OF AUSTIN ELECTRIC UTILITY DESIGN CRITERIA MANUAL, LATEST ADOPTED EDITION.

- NOTES:**
1. ALL NON-CURRENT CARRYING METALLIC PARTS TO BE EFFECTIVELY BONDED.
 2. GROUNDING ELECTRODE AND GROUNDING ELECTRODE CONDUCTOR PER COA ELECTRIC CODE.
 3. EXPOSED WIRES SHALL BE COLOR CODED, COLORED MARKING TAPE MAY BE USED AT TERMINATION POINTS.
 4. CONNECT BONDING STRAP OR INSTALL GREEN BONDING SCREW TO NEUTRAL BUSBAR TO GROUND METAL ENCLOSURE.
 5. NO FITTINGS, SUCH AS COUPLINGS, MAY BE LOCATED BETWEEN THE ROOF AND POINT OF ATTACHMENT (ONE POINT RACK).
 6. WHEN GUYING IS REQUIRED A 3/16" X 1" COMMON GALVANIZED PIPE BAND AND 1/4" THIMBLE SHALL BE ATTACHED BELOW THE SERVICE ATTACHMENT POINT. 1/4" COMMON GALVANIZED STEEL STRAND OR EQUAL SHALL BE INSTALLED AT A 45° ANGLE TO ROOF. (2 GUYS REQUIRED) THE GUYS SHALL ATTACH TO ROOF WITH ROOF PLATE BOLTED TO ROOF RAFTERS. 1/4" THIMBLE AND GUY CLAMP SHALL BE USED TO ATTACH GUY WIRE TO ROOF PLATE. EYE BOLTS AND WASHERS ARE ACCEPTABLE FOR GUY PLATE GUY WIRE ATTACHMENT. EYE LAGS ARE NOT ACCEPTABLE.

Figure 1-19. Underground Service Installation (Residential – Typical Installation)

1-19	UNDERGROUND SERVICE INSTALLATION RESIDENTIAL 120/240 VOLT SINGLE PHASE TYP. INSTALLATION	
SHEET 1 OF 1		
11/14/21		

REFERENCES:
 NATIONAL ELECTRIC CODE & CITY OF
 AUSTIN ELECTRIC UTILITY DESIGN
 CRITERIA MANUAL, LATEST ADOPTED
 EDITION.

- NOTES:**
1. ALL NON-CURRENT CARRYING METALLIC PARTS TO BE EFFECTIVELY BONDED.
 2. GROUNDING ELECTRODE AND GROUNDING ELECTRODE CONDUCTOR PER COA ELECTRIC CODE.
 3. EXPOSED WIRES SHALL BE COLOR CODED, COLORED MARKING TAPE MAY BE USED AT TERMINATION POINTS.
 4. CONNECT BONDING STRAP OR INSTALL GREEN BONDING SCREW TO NEUTRAL BUSBAR TO GROUND METAL ENCLOSURE.
 5. SERVICE ADDRESS MUST BE ON METER CAN OR BREAKER ENCLOSURE.

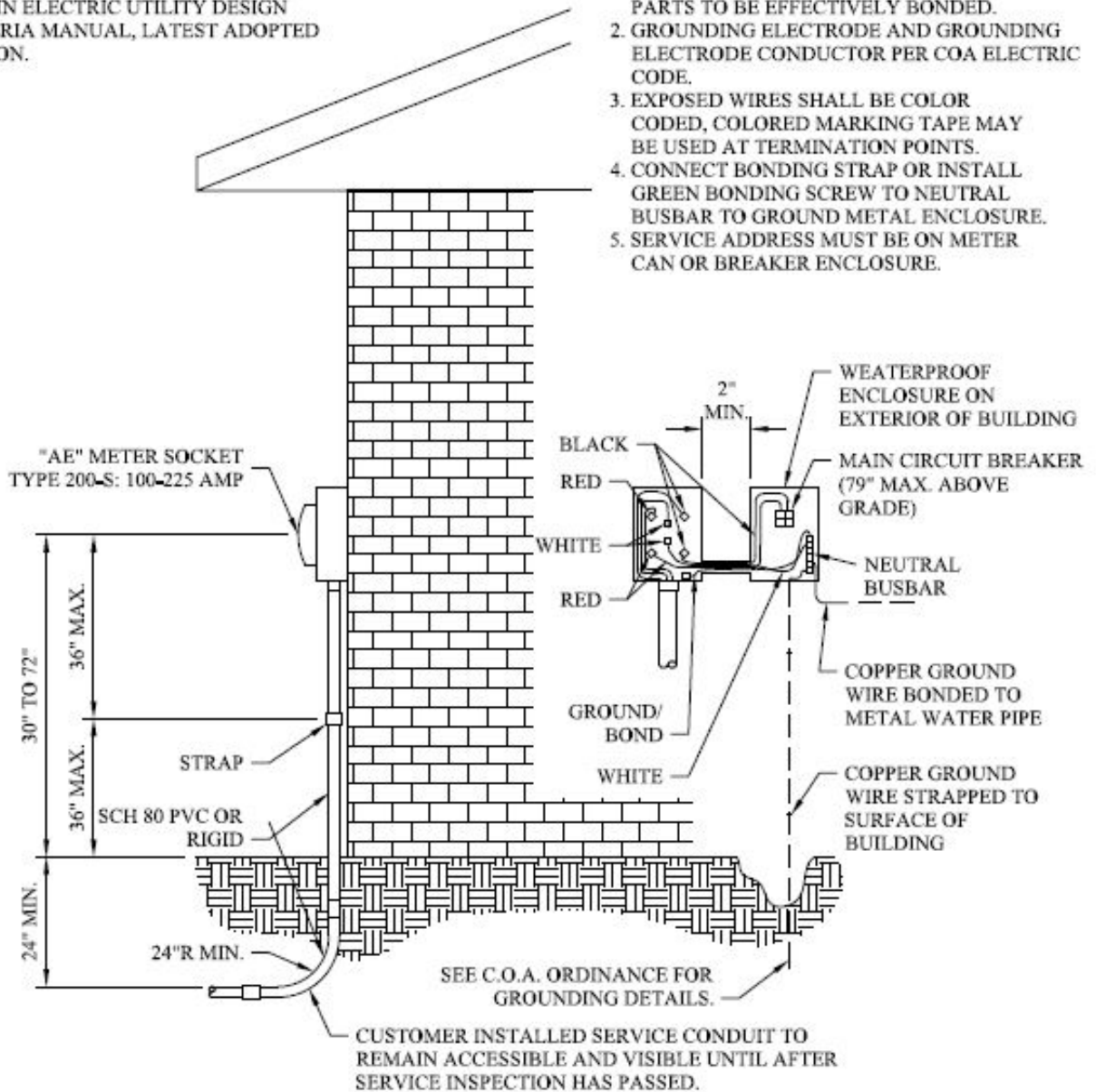

Figure 1-20. Meter Loop for Permanent Overhead Service Installation (Commercial – Typical Installation)

1-20	METER LOOP FOR PERMANENT OVERHEAD SERVICE INSTALLATION COMMERCIAL 120/240 & 120//208 VOLT SINGLE PHASE TYP INSTALLATION	
SHEET 1 OF 1		
11/14/21		

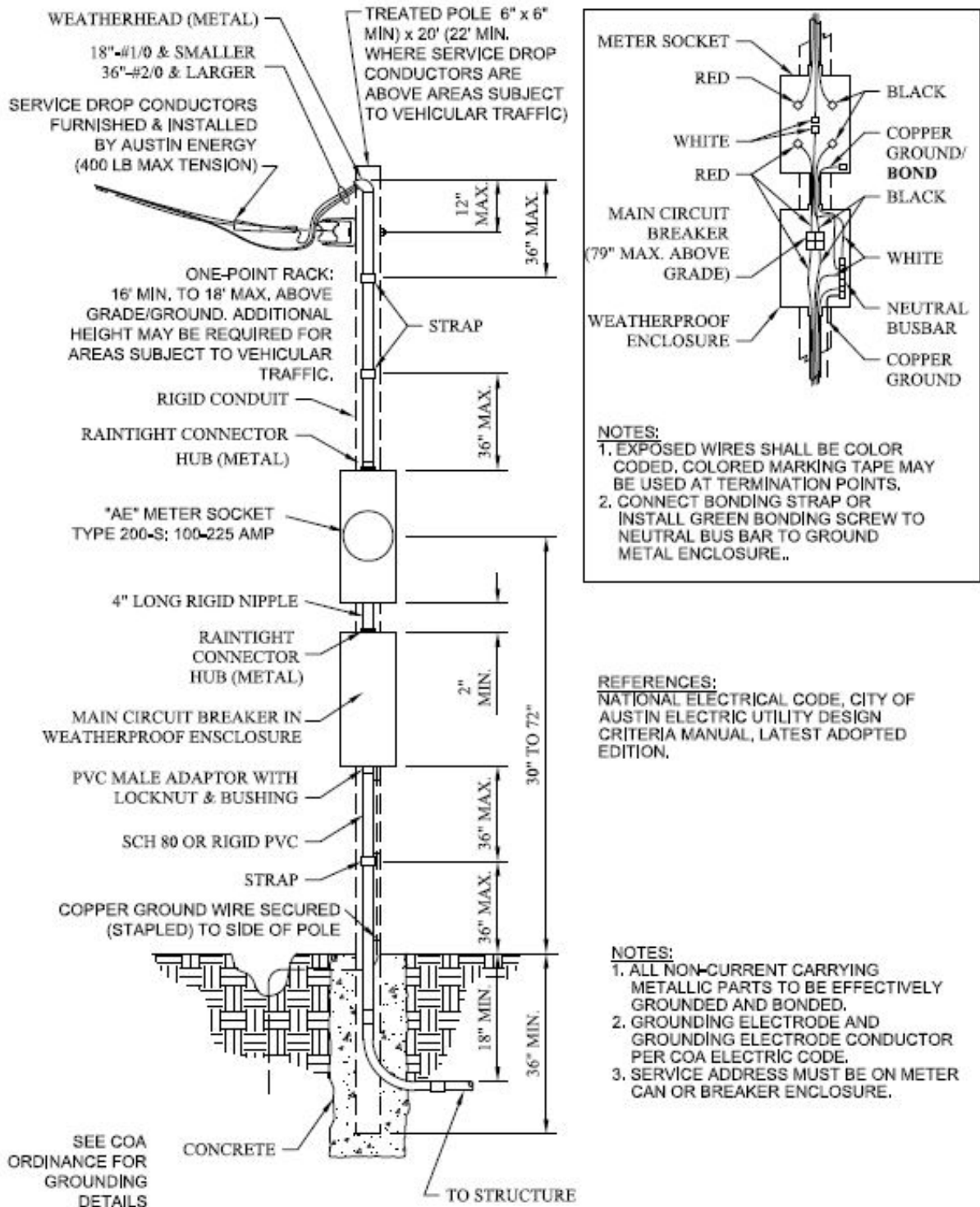

Figure 1-21. Under-Eaves Service Installation (Commercial – Typical Installation)

1-21	UNDER EAVES SERVICE INSTALLATION	
SHEET 1 OF 1	COMMERCIAL 120/240 & 120//208 VOLT SINGLE PHASE TYP INSTALLATION	
11/14/21		

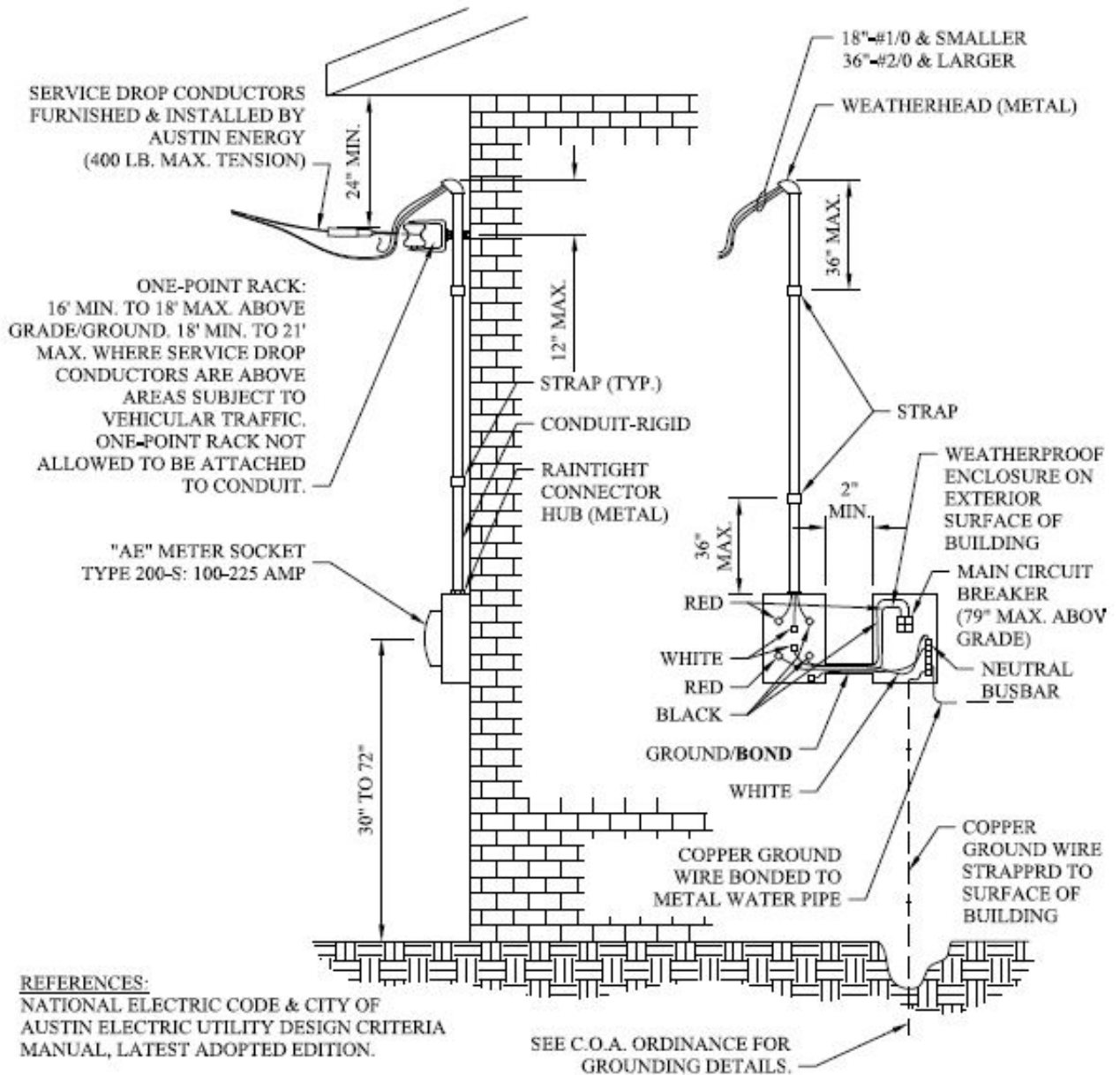
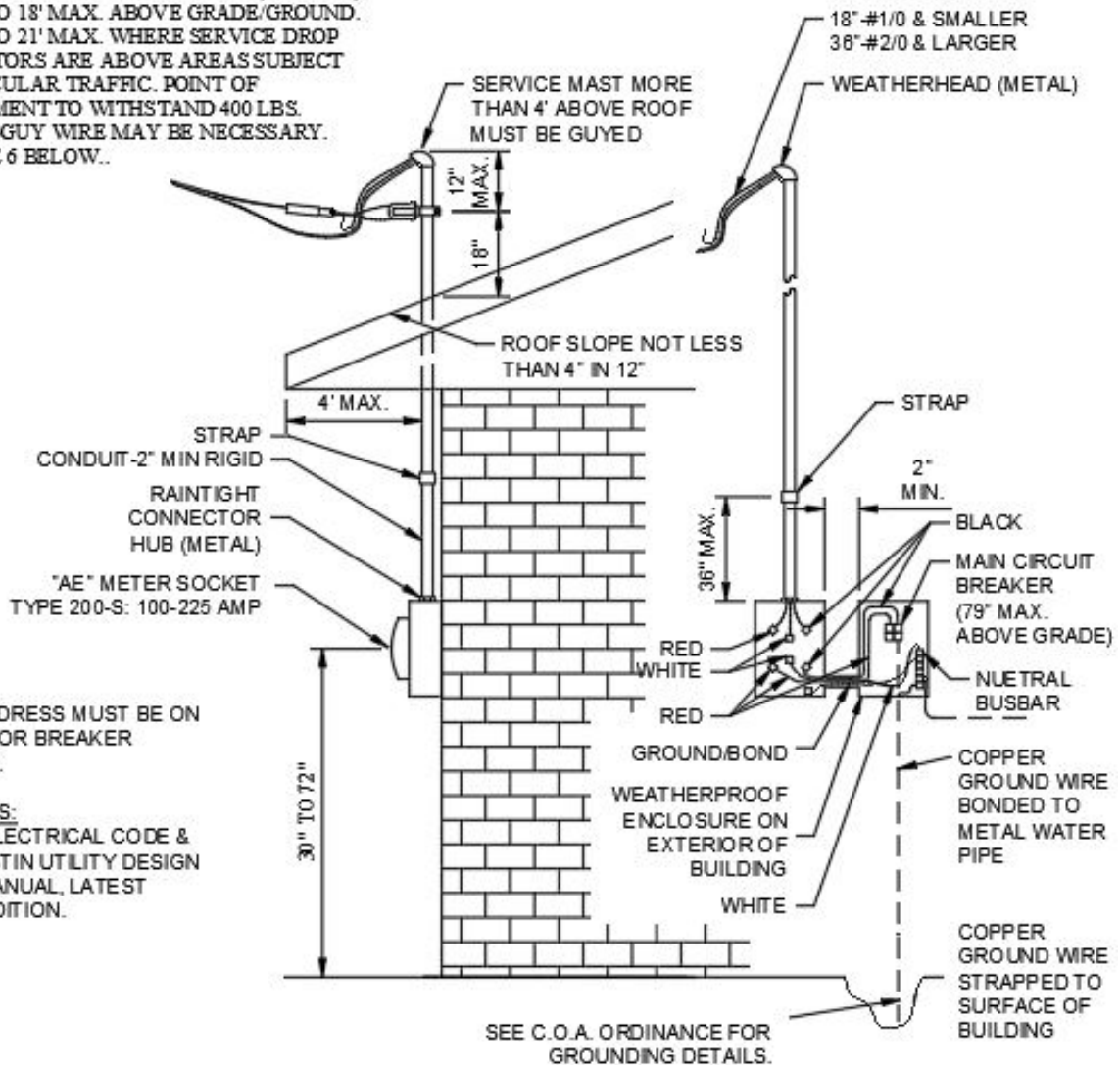

Figure 1-22. Through-Roof Service Mast Installation (Commercial – Typical Installation)

1-22	THROUGH ROOF SERVICE MAST INSTALLATION	
SHEET 1 OF 1	COMMERCIAL 120/240 & 120//208 VOLT SINGLE PHASE TYP INSTALLATION	
11/14/21		

ONE-POINT RACK1 (CLAP ON):
 16' MIN. TO 18' MAX. ABOVE GRADE/GROUND.
 18' MIN. TO 21' MAX. WHERE SERVICE DROP
 CONDUCTORS ARE ABOVE AREAS SUBJECT
 TO VEHICULAR TRAFFIC. POINT OF
 ATTACHMENT TO WITHSTAND 400 LBS.
 TENSION-GUY WIRE MAY BE NECESSARY.
 SEE NOTE 6 BELOW..



NOTE:
 SERVICE ADDRESS MUST BE ON
 METER CAN OR BREAKER
 ENCLOSURE.

REFERENCES:
 NATIONAL ELECTRICAL CODE &
 CITY OF AUSTIN UTILITY DESIGN
 CRITERIA MANUAL, LATEST
 ADOPTED EDITION.

NOTES:

1. ALL NON-CURRENT CARRYING METALLIC PARTS TO BE EFFECTIVELY GROUNDED AND BONDED.
2. GROUNDING ELECTRODE AND GROUNDING ELECTRODE CONDUCTOR PER COA ELECTRIC CODE.
3. EXPOSED WIRES SHALL BE COLOR CODED, COLORED MARKING TAPE MAY BE USED AT TERMINATION POINTS.
4. CONNECT BONDING STRAP OR INSTALL GREEN BONDING SCREW TO NEUTRAL BUSBAR TO GROUND METAL ENCLOSURE.
5. NO FITTINGS, SUCH AS COUPLINGS, MAY BE LOCATED BETWEEN THE ROOF AND POINT OF ATTACHMENT (ONE POINT RACK).
6. WHEN GUYING IS REQUIRED A 3/16" X 1" COMMON GALVANIZED PIPE BAND AND 1/4" THIMBLE SHALL BE ATTACHED BELOW THE SERVICE ATTACHMENT POINT. 1/4" COMMON GALVANIZED STEEL STRAND OR EQUAL SHALL BE INSTALLED AT A 45° ANGLE TO ROOF. (2 GUYS REQUIRED) THE GUYS SHALL ATTACH TO ROOF WITH ROOF PLATE BOLTED TO ROOF RAFTERS. 1/4" THIMBLE AND GUY CLAMP SHALL BE USED TO ATTACH GUY WIRE TO ROOF PLATE. EYE BOLTS AND WASHERS ARE ACCEPTABLE FOR GUY PLATE GUY WIRE ATTACHMENT. EYE LAGS ARE NOT ACCEPTABLE.

Figure 1-23. Underground Service Installation (Commercial – Typical Installation)

1-23	COMMERCIAL UNDERGROUND SERVICE INSTALLATION	
SHEET 1 OF 1	COMMERCIAL 120/240 & 120//208 VOLT SINGLE PHASE	
5/14/21	TYP INSTALLATION	

REFERENCES:
 NATIONAL ELECTRIC CODE & CITY OF
 AUSTIN ELECTRIC UTILITY DESIGN
 CRITERIA MANUAL, LATEST ADOPTED
 EDITION.

- NOTES:**
1. ALL NON-CURRENT CARRYING METALLIC PARTS TO BE EFFECTIVELY BONDED.
 2. GROUNDING ELECTRODE AND GROUNDING ELECTRODE CONDUCTOR PER COA ELECTRIC CODE.
 3. EXPOSED WIRES SHALL BE COLOR CODED, COLORED MARKING TAPE MAY BE USED AT TERMINATION POINTS.
 4. CONNECT BONDING STRAP OR INSTALL GREEN BONDING SCREW TO NEUTRAL BUSBAR TO GROUND METAL ENCLOSURE.
 5. SERVICE ADDRESS MUST BE ON METER CAN OR BREAKER ENCLOSURE.

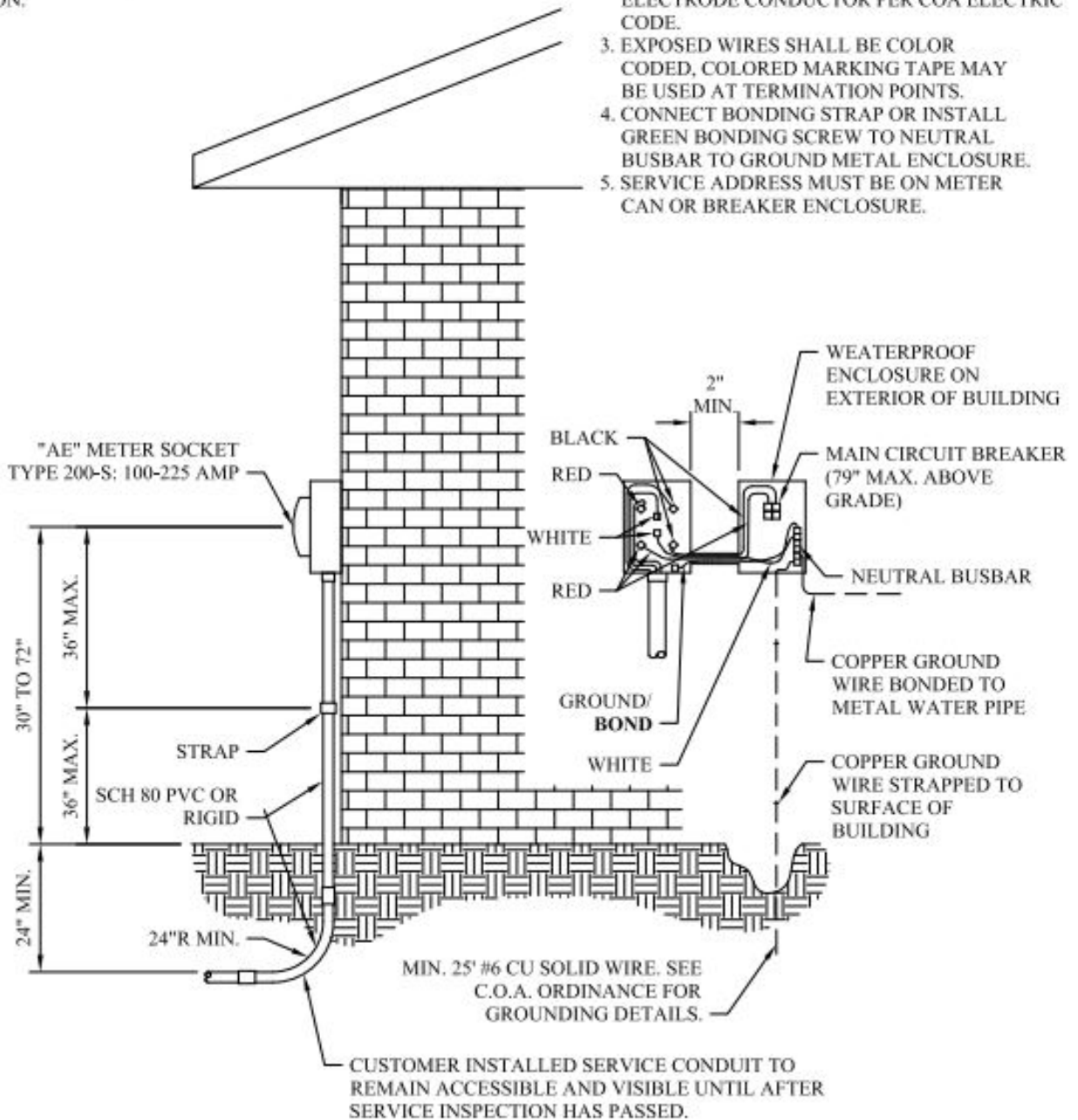

UNDERGROUND FROM SERVICE POINT (TRANSFORMER, SERVICE BOX, PULLBOX) TO METER:
 CUSTOMER FURNISHES & INSTALLS WIRE & SERVICE CONDUIT FROM METER TO SERVICE POINT.

Figure 1-24. Two-Meter Permanent Overhead Installation (Typical Installation)

I-24	TWO METER PERMANENT OVERHEAD INSTALLATION (TYPICAL INSTALLATION)	
SHEET 1 OF 1	120/240 & 120//208 VOLT SINGLE PHASE INSTALLATION	
5/14/21		

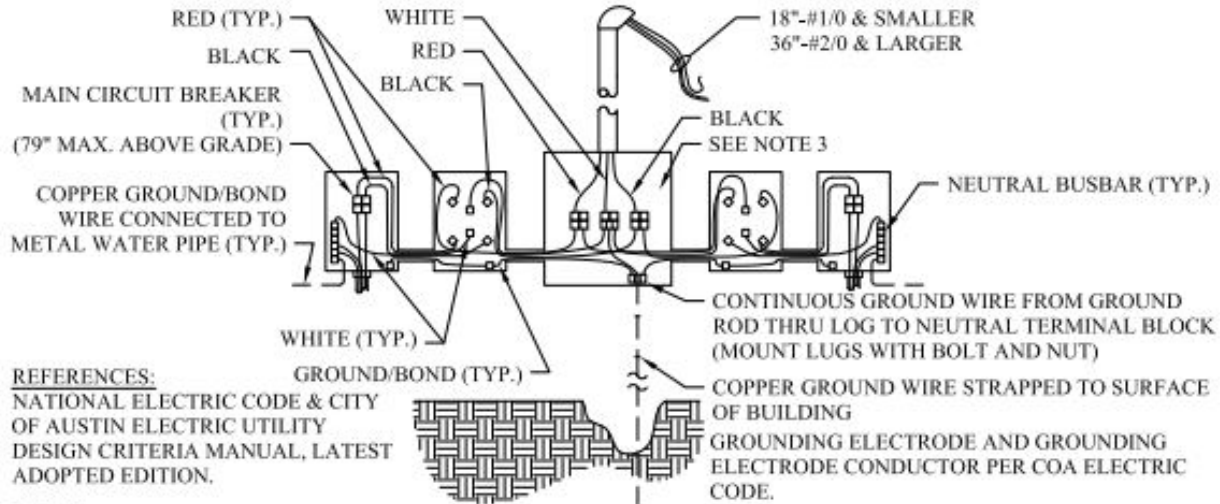

REFERENCES:
 NATIONAL ELECTRIC CODE & CITY OF AUSTIN ELECTRIC UTILITY DESIGN CRITERIA MANUAL, LATEST ADOPTED EDITION.

- NOTES:**
1. ALL NON-CURRENT CARRYING METALLIC PARTS TO BE EFFECTIVELY GROUNDING AND BONDED.
 2. EXPOSED WIRES SHALL BE COLOR CODED, COLORED MARKING TAPE MAY BE USED AT TERMINATION POINTS.
 3. CONNECT BONDING STRAP OR INSTALL GREEN BONDING SCREW TO NEUTRAL BUSBAR TO GROUND METAL ENCLOSURE.
 4. THE GROUNDING AND BONDING WIRE FOR THE SERVICE SHALL TERMINATE IN SERVICE DISTRIBUTION ENCLOSURE.

NOTE:
 SERVICE ADDRESS MUST BE ON METER CAN OR BREAKER ENCLOSURE.

ONE POINT RACK:
 RESIDENTIAL- 12'6" MIN. TO 15' MAX.
 COMMERCIAL- 16' MIN. TO 18' MAX.
 (ADDITIONAL HEIGHT MAY BE REQUIRED FOR AREAS SUBJECT TO VEHICULAR TRAFFIC.)

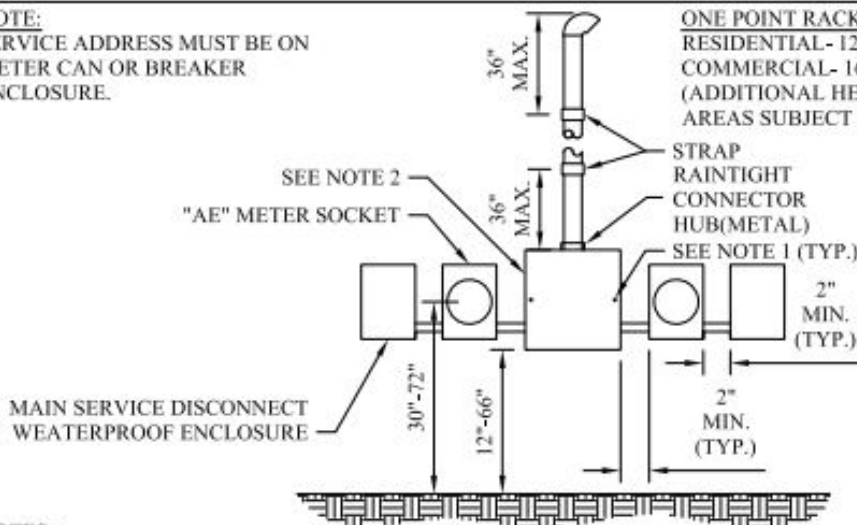

- NOTES:**
1. 3/16" DIAMETER HOLE DRILLED FOR AUSTIN ENERGY TO INSTALL UTILITY SEAL.
 2. THE SERVICE DISTRIBUTION ENCLOSURE SHALL BE EITHER A BUS ENCLOSURE WITH A MAXIMUM 2500 AMP SERVICE SIZE OR A JUNCTION BOX WITH A MAXIMUM 1200 AMP SERVICE SIZE. THE JUNCTION BOX SHALL BE EQUIPPED WITH TERMINAL BLOCKS AND SIZED ACCORDING TO THE TABLE "JUNCTION BOX AND WIREWAY SPECIFICATIONS" IN APPENDIX C. THE 1200 AMP MAXIMUM DOES NOT APPLY TO RESIDENTIAL INSTALLATIONS.
 3. SERVICE RISER CONDUIT SHALL BE RIGID METAL. (IMC, OR EMT - EMT NOT PERMITTED FOR SERVICE MAST THROUGH ROOF.) THROUGH ROOF MUST BE RIGID METAL.

Figure 1-25. Two-Meter Permanent Underground Installation (Typical Installation)

1-25	TWO METER PERMANENT UNDERGROUND INSTALLATION	
SHEET 1 OF 1	120/240 & 120//208 VOLT SINGLE PHASE TYP INSTALLATION	
5/14/21		

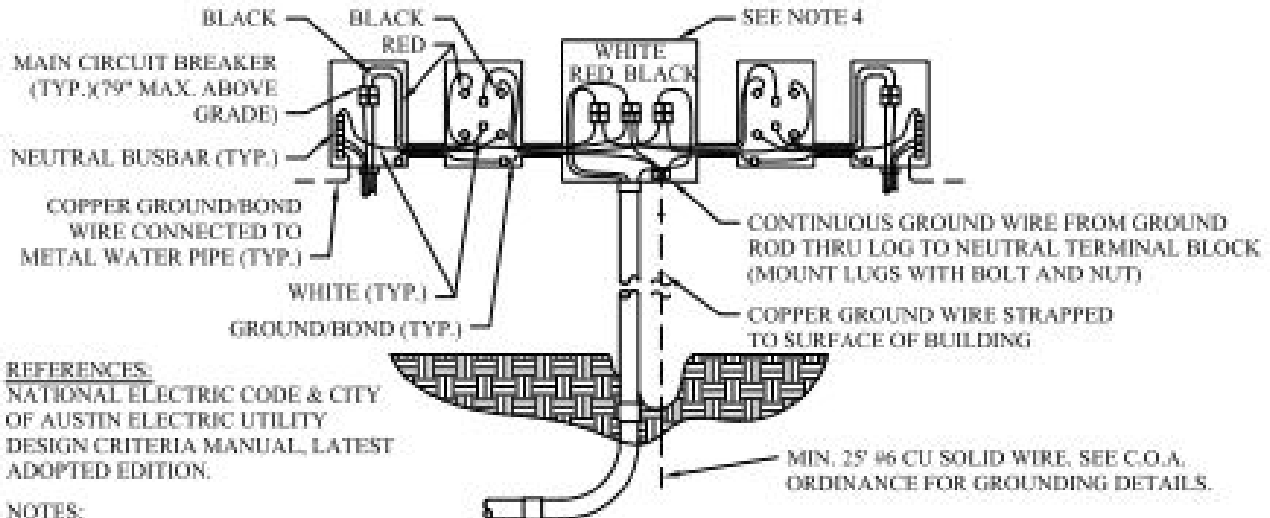

REFERENCES:
 NATIONAL ELECTRIC CODE & CITY OF AUSTIN ELECTRIC UTILITY DESIGN CRITERIA MANUAL, LATEST ADOPTED EDITION.

- NOTES:**
1. ALL NON-CURRENT CARRYING METALLIC PARTS TO BE EFFECTIVELY GROUNDING AND BONDED.
 2. GROUNDING ELECTRODE AND GROUNDING ELECTRODE CONDUCTOR PER COA ELECTRIC CODE.
 3. EXPOSED WIRES SHALL BE COLOR CODED, COLORED MARKING TAPE MAY BE USED AT TERMINATION POINTS.
 4. CONNECT BONDING STRAP OR INSTALL GREEN BONDING SCREW TO NEUTRAL BUSBAR TO GROUND METAL ENCLOSURE.
 5. THE GROUNDING AND BONDING WIRE FOR THE SERVICE SHALL TERMINATE IN THE SERVICE DISTRIBUTION ENCLOSURE.

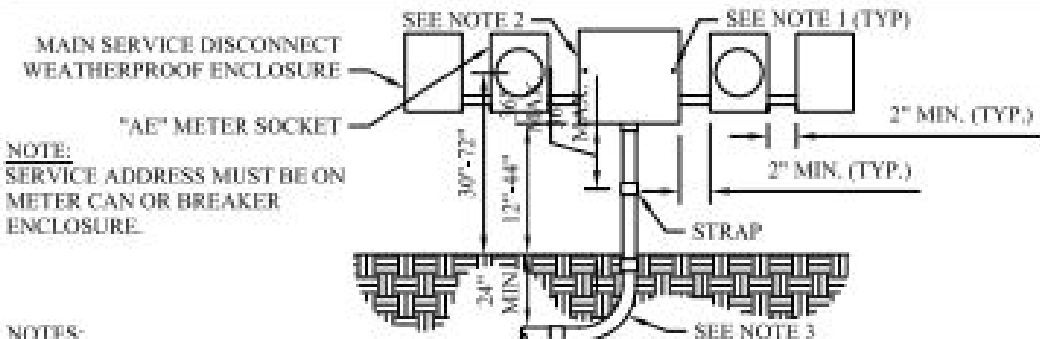

- NOTES:**
1. 3/16" DIAMETER HOLE DRILLED FOR AUSTIN ENERGY TO INSTALL UTILITY SEAL.
 2. THE SERVICE DISTRIBUTION ENCLOSURE SHALL BE EITHER A BUS ENCLOSURE WITH A MAXIMUM 2500 AMP SERVICE SIZE OR A JUNCTION BOX WITH A MAXIMUM 1200 AMP SERVICE SIZE. THE JUNCTION BOX SHALL BE EQUIPPED WITH TERMINAL BLOCKS AND SIZED ACCORDING TO THE TABLE "JUNCTION BOX AND WIREWAY SPECIFICATIONS" IN APPENDIX C. THE 1200 AMP MAXIMUM DOES NOT APPLY TO RESIDENTIAL INSTALLATIONS.
 3. **UNDERGROUND RESIDENTIAL:** CUSTOMER FURNISHES & INSTALLS SCH. 80 PVC SERVICE CONDUIT FROM BOTTOM OF 90° TO TRANSFORMER/SERVICE BOX.
UNDERGROUND COMMERCIAL: CUSTOMER FURNISHES & INSTALLS SERVICE CONDUIT & LATERAL CONDUCTORS FROM METER BASE/SERVICE DISTRIBUTION ENCLOSURE TO TRANSFORMER/POINT OF SERVICE. (THE 90° BEND AND THE CONDUIT UP TO THE METER BASE/SERVICE DISTRIBUTION ENCLOSURE SHALL BE SCH 80 PVC OR RIGID METAL. THE CONDUIT FROM THE BOTTOM OF 90° BEND TO TRANSFORMER/SERVICE BOX SHALL BE SCH 40 PVC.)
 4. WHEN AUSTIN ENERGY CONDUCTORS TERMINATE IN JUNCTION BOX, TERMINAL BLOCKS SHALL BE MOUNTED IN JUNCTION BOX.

Figure 1-26. 3 to 12 Meters for Permanent Overhead or Underground Installation (Typical Installation)

1-26	3-12 METERS FOR PERMANENT OVERHEAD OR UNDERGROUND 120/240 & 120//208 VOLT TYP INSTALLATION	
SHEET 1 OF 1		
11/15/22		

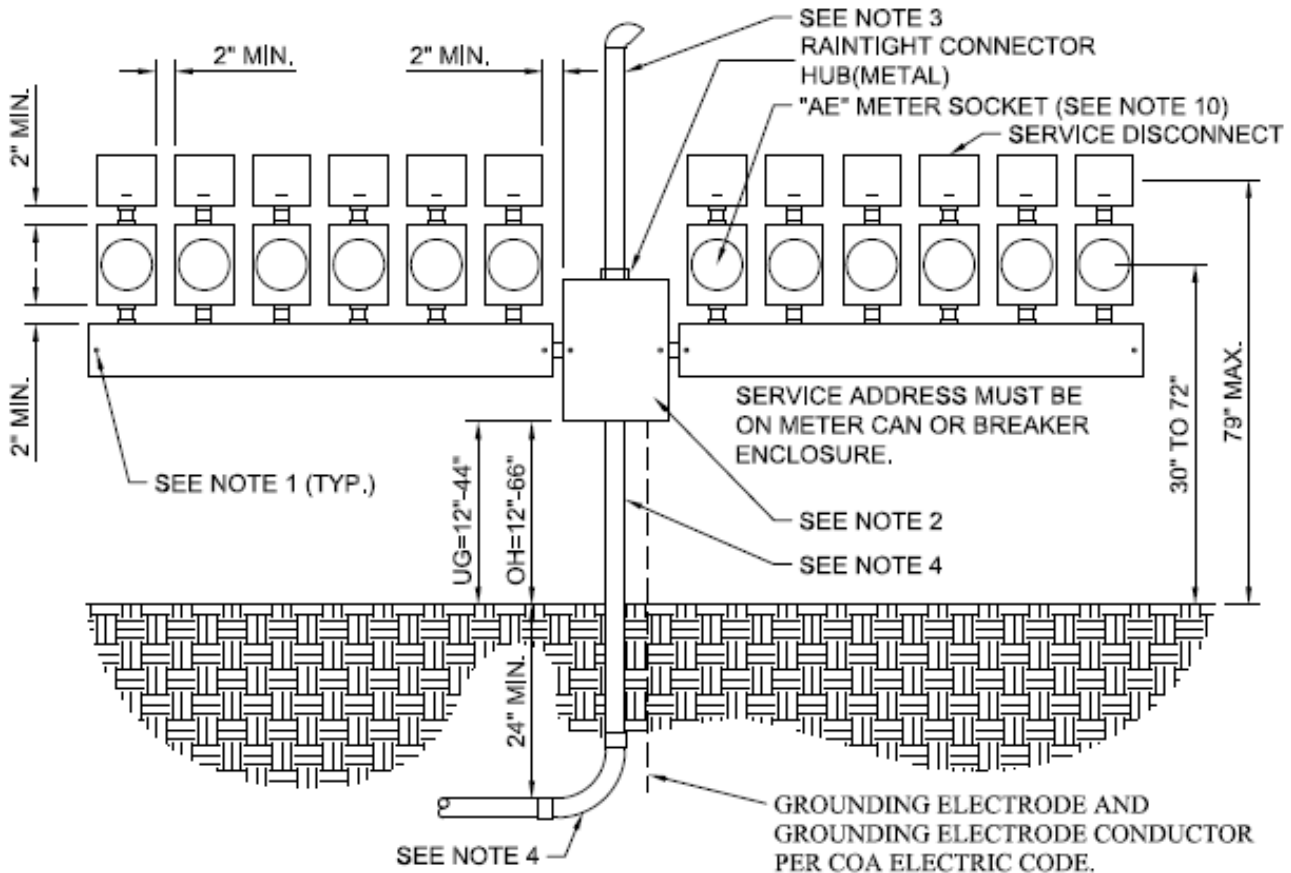

NOTES:

1. 3/16" DIAMETER HOLE DRILLED FOR AUSTIN ENERGY TO INSTALL UTILITY SEAL.
2. THE SERVICE DISTRIBUTION ENCLOSURE SHALL BE EITHER A BUS ENCLOSURE WITH A MAXIMUM 2500 AMP SERVICE SIZE OR A JUNCTION BOX WITH A MAXIMUM 1200 AMP SERVICE SIZE. THE JUNCTION BOX SHALL BE EQUIPPED WITH TERMINAL BLOCKS AND SIZED ACCORDING TO THE TABLE "JUNCTION BOX AND WIREWAY SPECIFICATIONS" IN APPENDIX C. THE 1200 AMP MAXIMUM DOES NOT APPLY TO RESIDENTIAL INSTALLATIONS.
3. OVERHEAD INSTALLATION: SERVICE RISER CONDUIT SHALL BE RIGID METAL. (MC OR EMT) EMT NOT PERMITTED FOR SERVICE MAST THROUGH ROOF. THROUGH ROOF MUST BE RIGID METAL.
4. UNDERGROUND RESIDENTIAL: CUSTOMER SHALL FURNISH & INSTALL SCH. 80 PVC SERVICE CONDUIT FROM BOTTOM OF 90° TO TRANSFORMER/SERVICE BOX.
UNDERGROUND COMMERCIAL: CUSTOMER SHALL FURNISH & INSTALL SERVICE CONDUIT & LATERAL CONDUCTORS FROM METER BASE/SERVICE DISTRIBUTION ENCLOSURE TO TRANSFORMER/POINT OF SERVICE. (THE 90° BEND AND THE CONDUIT UP TO THE METER BASE/SERVICE DISTRIBUTION ENCLOSURE SHALL BE SCH 80 PVC OR RIGID METAL. THE CONDUIT FROM THE BOTTOM OF 90° BEND TO TRANSFORMER/SERVICE BOX SHALL BE SCH 40 PVC.)
5. 277/480 VOLT, 3 PHASE, 4 WIRE: THE SERVICE DISCONNECT SHALL BE BETWEEN THE LINE WIREWAY THE METER SOCKET. (LINE-WIREWAY-DISCONNECT-METER-LOAD).
6. WHEN AUSTIN ENERGY CONDUCTORS TERMINATE IN JUNCTION BOX, TERMINAL BLOCKS SHALL BE MOUNTED IN JUNCTION BOX.
7. CONTACT A.E. METER OPERATIONS CONCERNING MODULAR METERING.
8. ALL NON-CURRENT CARRYING METALLIC PARTS TO BE EFFECTIVELY GROUNDED AND BONDED.
9. ALL GROUNDING AND SYSTEM BOND WIRE SHALL TERMINATE IN SERVICE DISTRIBUTION ENCLOSURE.
10. MULTI-UNIT PROJECTS THAT ARE USING MODULAR METERING EQUIPMENT ARE ALLOWED TO USE 125A METER SOCKETS PER CURRENT AE SPECIFICATION E-1589 THAT IS LOCATED ON THE AE WEBSITE.
11. ALL METER SOCKETS ARE REQUIRED TO BE 200 AMP, RINGLESS, WITH LOCKING JAW LEVER BYPASS.

Figure 1-27. 13 to 18 Meters for Permanent Overhead or Underground Installation (Typical Installation)

1-27	3-18 METERS FOR PERMANENT OVERHEAD OR UNDERGROUND 120/240 & 120//208 VOLT TYP INSTALLATION	
SHEET 1 OF 1		
11/15/22		

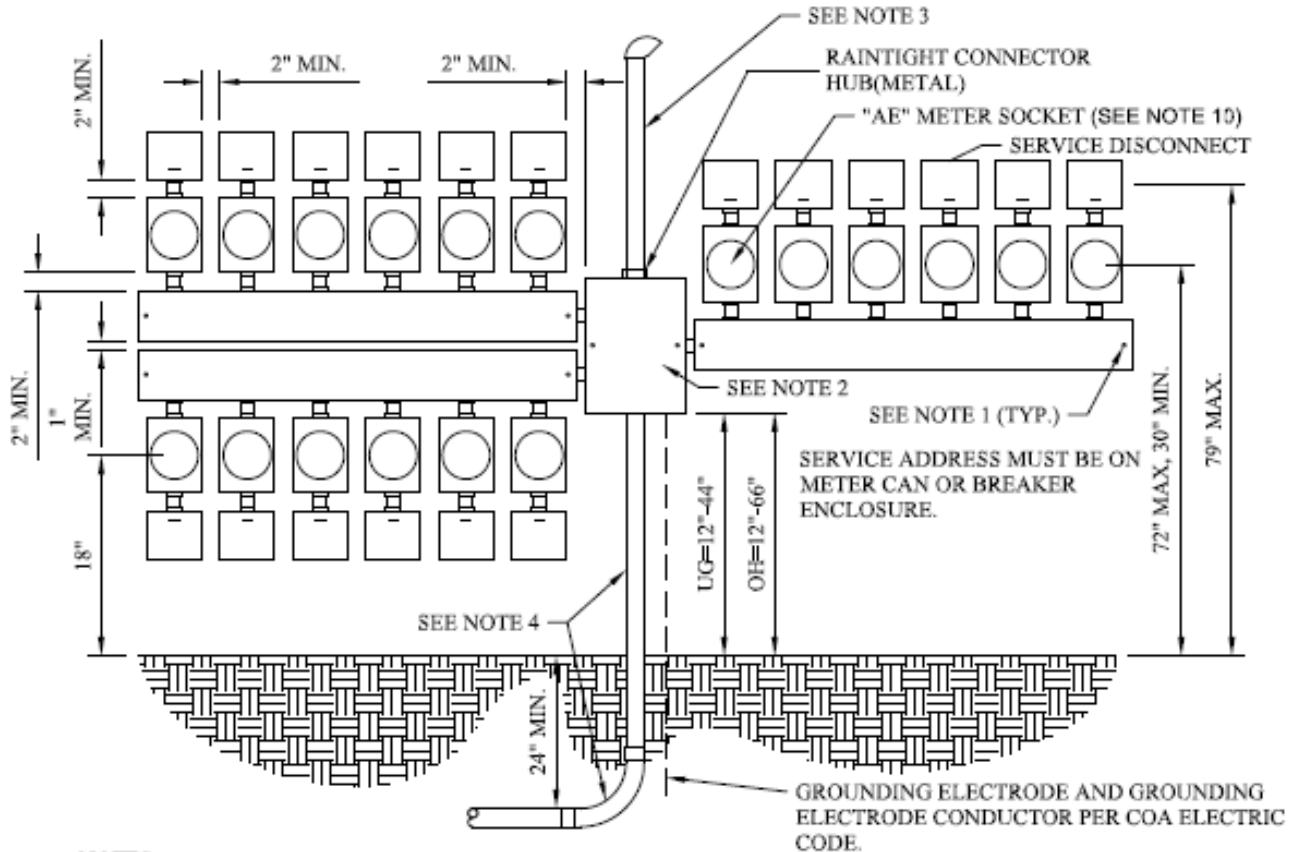

NOTES:

1. 3/16" DIAMETER HOLE DRILLED FOR AUSTIN ENERGY TO INSTALL UTILITY SEAL.
2. THE SERVICE DISTRIBUTION ENCLOSURE SHALL BE EITHER A BUS ENCLOSURE WITH A MAXIMUM 2500 AMP SERVICE SIZE OR A JUNCTION BOX WITH A MAXIMUM 1200 AMP SERVICE SIZE. THE JUNCTION BOX SHALL BE EQUIPPED WITH TERMINAL BLOCKS AND SIZED ACCORDING TO "1.14.1 DISTRIBUTION SERVICE ENCLOSURE (TAP BOX, JUNCTION BOX) AND WIREWAY SPECIFICATIONS" IN APPENDIX C. THE 1200 AMP MAXIMUM DOES NOT APPLY TO RESIDENTIAL INSTALLATIONS.
3. OVERHEAD INSTALLATION: SERVICE RISER CONDUIT SHALL BE RIGID METAL, IMC, OR EMT.(IMC AND EMT NOT PERMITTED FOR SERVICE MAST THROUGH ROOF.)
4. UNDERGROUND RESIDENTIAL: CUSTOMER SHALL FURNISH & INSTALL SCH. 80 PVC SERVICE CONDUIT FROM BOTTOM OF 90° BEND TO TRANSFORMER/SERVICE BOX.
UNDERGROUND COMMERCIAL: CUSTOMER SHALL FURNISH & INSTALL SCH. 80 PVC SERVICE CONDUIT & LATERAL CONDUCTORS FROM METER BASE/SERVICE DISTRIBUTION ENCLOSURE TO TRANSFORMER/POINT OF SERVICE. (THE 90° BEND AND THE CONDUIT UP TO THE METER BASE/SERVICE DISTRIBUTION ENCLOSURE SHALL BE SCH 80 PVC OR RIGID METAL. THE CONDUIT FROM THE BOTTOM OF 90° BEND TO TRANSFORMER/SERVICE BOX SHALL BE SCH 40 PVC.)
5. 277/480 VOLT, 3 PHASE, 4 WIRE: THE SERVICE DISCONNECT SHALL BE BETWEEN THE LINE WIREWAY & THE METER SOCKET. (LINE-WIREWAY-DISCONNECT-METER-LOAD)
6. WHEN AUSTIN ENERGY CONDUCTORS TERMINATE IN JUNCTION BOX, TERMINAL BLOCKS SHALL BE MOUNTED IN JUNCTION BOX.
7. CONTACT A.E. METER OPERATIONS CONCERNING MODULAR METERING.
8. ALL NON-CURRENT CARRYING METALLIC PARTS TO BE EFFECTIVELY GROUNDING AND BONDED.
9. ALL GROUNDING AND SYSTEM BOND WIRE SHALL TERMINATE IN SERVICE DISTRIBUTION ENCLOSURE.
10. MULTI-UNIT PROJECTS THAT ARE USING MODULAR METERING EQUIPMENT ARE ALLOWED TO USE 125A METER SOCKETS PER CURRENT AE SPECIFICATION E-1589 THAT IS LOCATED ON THE AE WEBSITE.
11. ALL METER SOCKETS ARE REQUIRED TO BE 200 AMP, RINGLESS, WITH LOCKING JAW LEVER BYPASS.

Figure 1-37A Responsibilities from The Point of Service

1-37A	SERVICE LATERAL RESPONSIBILITIES	
SHEET 1 OF 1		
REV. 7/29/20		

1. RESIDENTIAL, SUBDIVISIONS (NOTE 1)

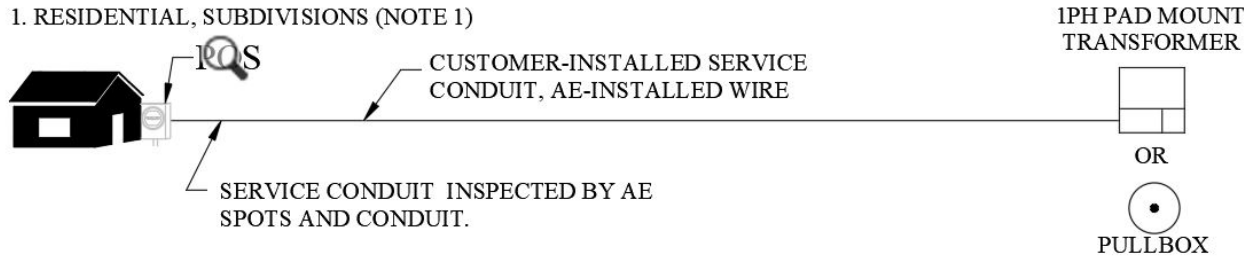

2. COMMERCIAL, APARTMENTS, CONDOS (NOTE 1)

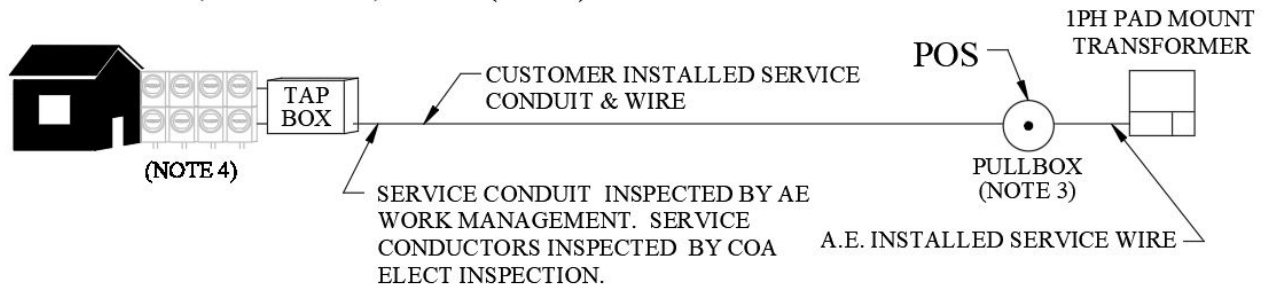

3. SECONDARY RISER (NOTE 8)

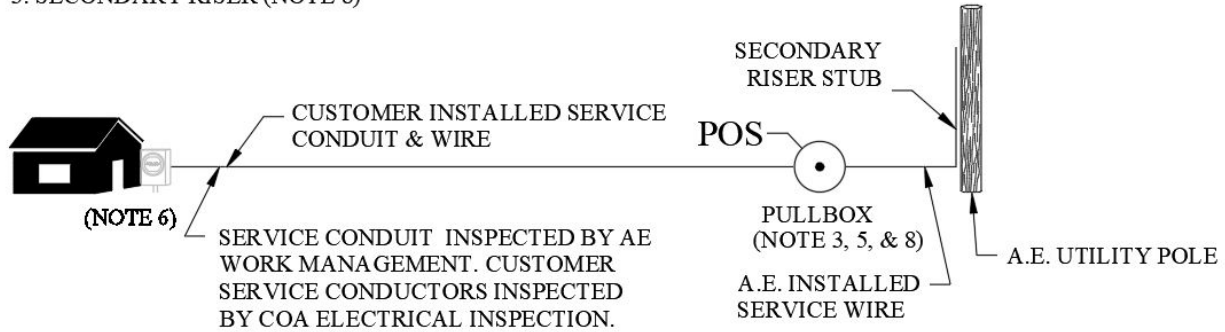

4. METER PEDESTAL OR METER RACK. (NOTES 4, 6, 7 & 9)

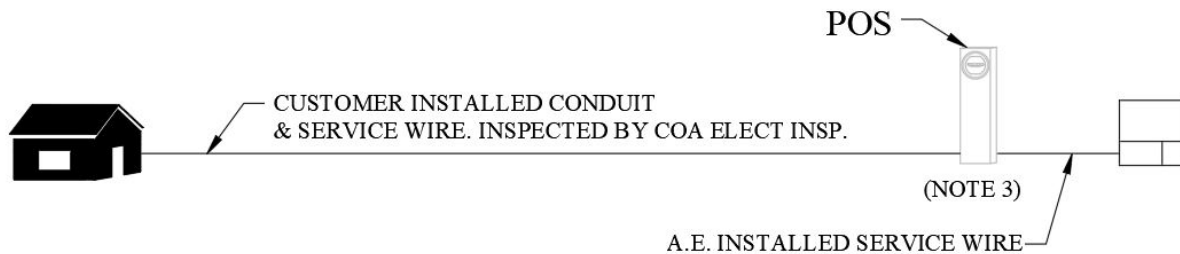
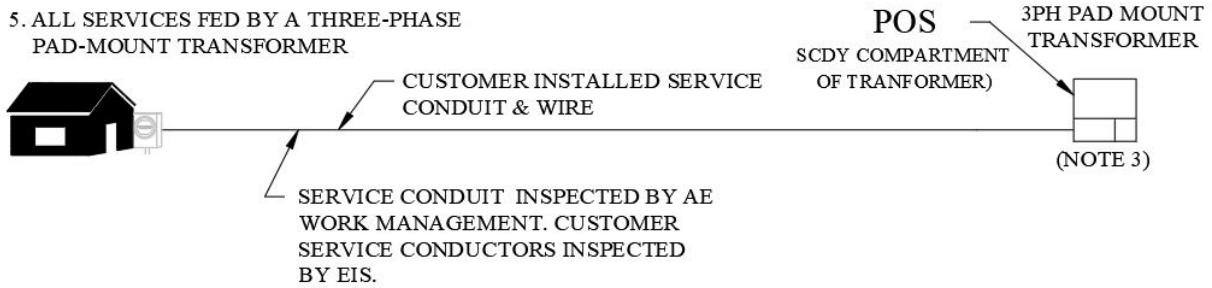

Figure 1-37B Responsibilities from the Point of Service

1-37B	SERVICE LATERAL RESPONSIBILITIES	
SHEET 1 OF 1		
REV. 7/29/20		

5. ALL SERVICES FED BY A THREE-PHASE PAD-MOUNT TRANSFORMER



6. ALL OVERHEAD SERVICES

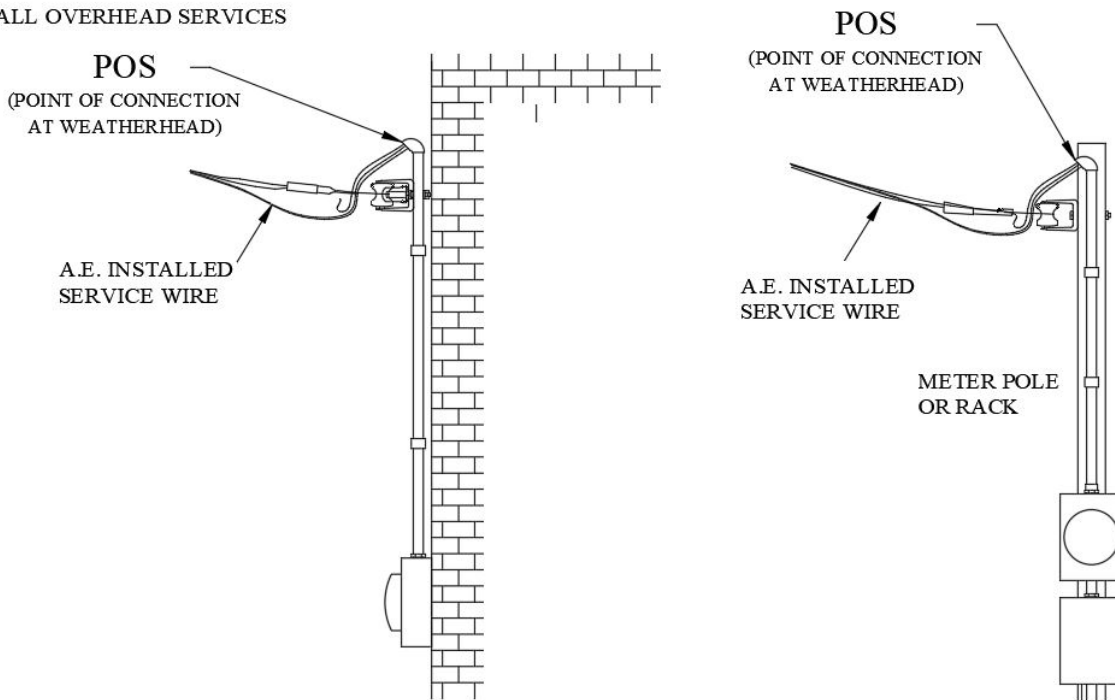



Figure 1-37C Responsibilities from the Point of Service

1-37C	SERVICE LATERAL RESPONSIBILITIES	
SHEET 1 OF 1		
REV. 7/29/20		

NOTES:

1. APPLIES TO ALL RESIDENTIAL SERVICES FED FROM A SINGLE-PHASE PAD-MOUNT TRANSFORMER.
2. APPLIES TO ALL COMMERCIAL SERVICES FED FROM A SINGLE-PHASE PAD-MOUNT TRANSFORMER.
3. CUSTOMERS SHALL NOT INSTALL CONDUIT OR CONDUCTOR INTO A PULL BOX OR AE EQUIPMENT CONTAINING ENERGIZED A.E. CONDUCTORS WITHOUT INSTRUCTION FROM AUSTIN ENERGY. CONTACT A.E. FOR INSTRUCTIONS.
4. FOR GROUPED, BANKED, OR MODULAR METERING, CONTACT A.E. ELECTRIC METER OPERATIONS SECTION.
5. FOR NEW SECONDARY RISER INSTALLATIONS, THE P.B., CONDUIT FROM THE P.B. TO THE RISER STUB, AND THE RISER STUB SHALL BE INSTALLED BY THE CUSTOMER AND INSPECTED BY A.E. WORK MANAGEMENT. A.E. WILL INSTALL THE SECONDARY RISER CONDUCTORS TO THE P.B.
6. CONTACT A.E. CT METER OPERATIONS FOR SINGLE-PHASE SERVICES OF 401 AMPERES OR MORE.
7. NORMALLY THE METER PEDESTAL IS INSTALLED WHEN THE CUSTOMER INSTALLS THE CONDUIT, P.B.'s AND TRANSFORMER PADS FOR THE A.E. URD PRIMARY CABLE, SECONDARY CABLE, AND PADMOUNTED TRANSFORMER INFRASTRUCTURE AND IS EXISTING AT THE TIME CUSTOMER INSTALLS HIS SERVICE LATERAL CONDUIT AND SERVICE CONDUCTORS. FOR NEW METER PEDESTALS, CONTACT A.E. DESIGN.
8. APPLIES TO SECONDARY RISER SERVICES. WHERE MULTIPLE PULL BOXES ARE ON THE LOAD SIDE OF THE TRANSFORMER, THE POINT OF SERVICE IS THE LAST PULL BOX CLOSEST TO THE METER.
9. FOR (NON-STANDARD) THREE-PHASE RESIDENTIAL SERVICES, SEE THE COMMERCIAL UNDERGROUND SERVICE LATERAL RESPONSIBILITIES DRAWING.
10. RESIDENTIAL SERVICE LATERAL INSPECTION REQUIREMENTS ARE DETERMINED BY THE RELATIVE LOCATIONS OF THE POINT OF SERVICE (POS) & A.E. METER.
 - A. NORMAL POS LOCATIONS FOR RESIDENTIAL SERVICE ARE SPECIFIED IN THE A.E. DESIGN CRITERIA MANUAL & IN THE A.E. CRITERIA MANUAL EXHIBIT HANDBOOK.
 - B. THE C.O.A. ELECTRIC INSPECTION (OR OTHER AUTHORIZED INSPECTION ENTITY) SETS THE REQUIREMENTS FOR AND INSPECTS ALL CUSTOMER INSTALLED AND OWNED SERVICE LATERAL CONDUCTORS ON THE LOAD SIDE OF THE POS.
 - C. A.E. SETS THE REQUIREMENTS FOR AND INSPECTS ALL CUSTOMER INSTALLED SERVICE LATERAL CONDUITS INSTALLED AHEAD OF (SOURCE-SIDE) AND INCLUDING THE POINT OF SERVICE.

KEY:

- POS- POINT OF SERVICE
P.B.- PULL-BOX OR SERVICE-BOX.